

general book 2024

Imagine, create, design.
Everyday, **we work to offer the best of ourselves.**

Imaginar, crear, diseñar.
Cada día, **trabajamos por ofrecer lo mejor de nosotros.**



We feel the need to create pieces that go beyond design and functionality. We provide anyone who wants to work with us with a unique differential.

Thanks to our continuous effort, we have avant-garde collections, with exclusive characteristics that add uniqueness to our projects. Year after year we continue to persevere in our know-how in order to improve ourselves, to reach new goals for us, for our customers who trust us when choosing high quality finishes, of high beauty.

Sentimos la necesidad de crear piezas que vayan más allá del diseño y la funcionalidad. Aportamos a todo aquel que quiera trabajar con nosotros un diferencial único.

Gracias a nuestro continuo esfuerzo somos poseedores de colecciones de vanguardia, de exclusivas características que añaden singularidad a los proyectos. Año tras año continuamos perseverando nuestro saber hacer para lograr superarnos, alcanzar nuevas metas para nosotros, para nuestros clientes que confían en nosotros a la hora de elegir acabados de alta calidad, de alta belleza.

made for
easy life

A **versatile selection** of ceramic solutions.
 Una **versátil selección** de soluciones cerámicas.

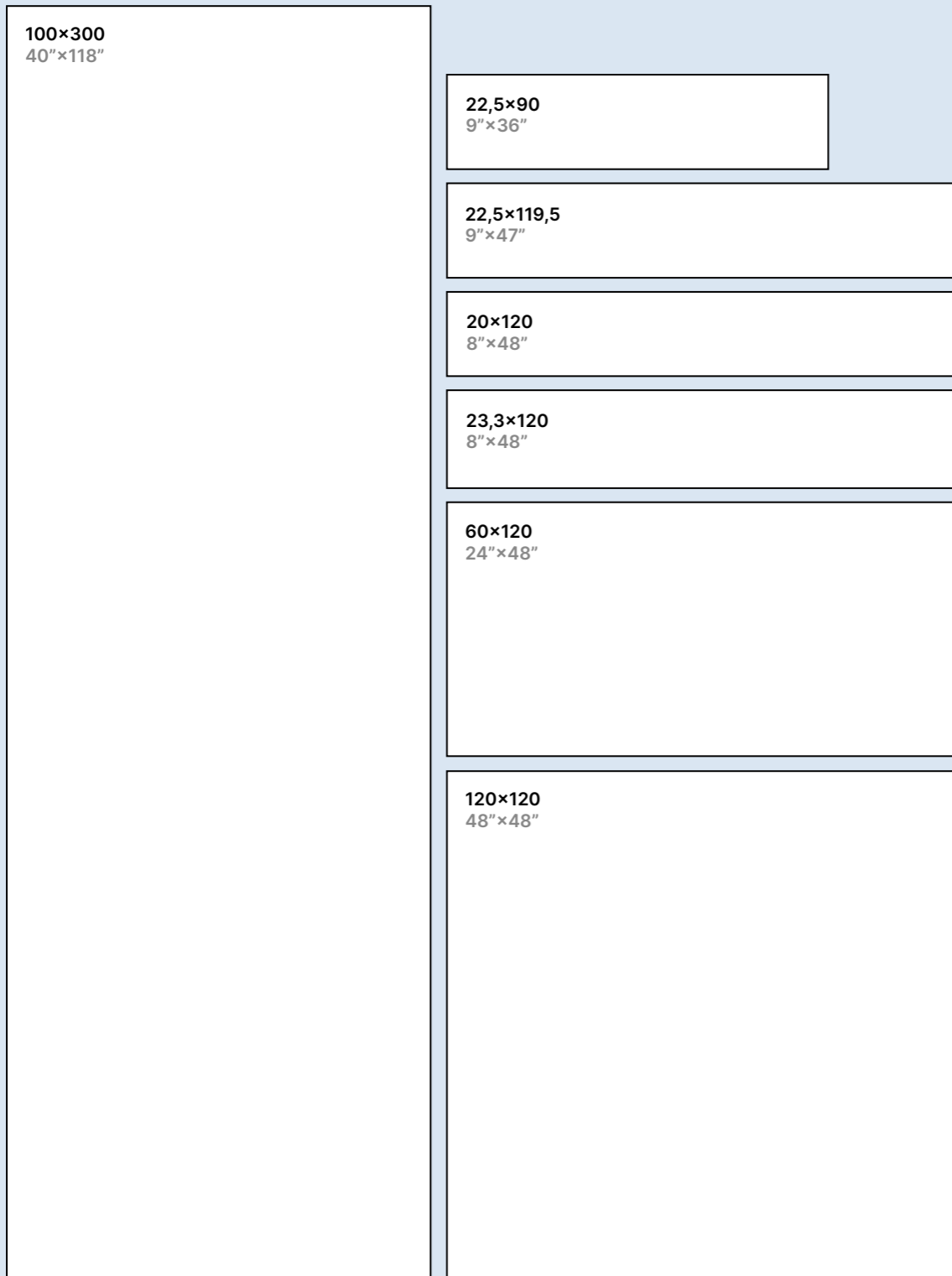

created
for ceramic
professionals

Commitment, efficiency and hard work. We are firmly committed to being one of the leading companies in product quality, at the forefront of design and always with impeccable service and quality. Our diversified variety of formats is designed to adapt to the aesthetic and functional needs of your space.

Empeño, eficacia y trabajo. Apostamos con firmeza por ser una de las empresas punteras en calidad de producto, a la vanguardia del diseño y siempre con un servicio impecable y de calidad. Nuestra diversificada variedad de formatos está pensada para adaptarse a las necesidades estéticas y funcionales de tu espacio.

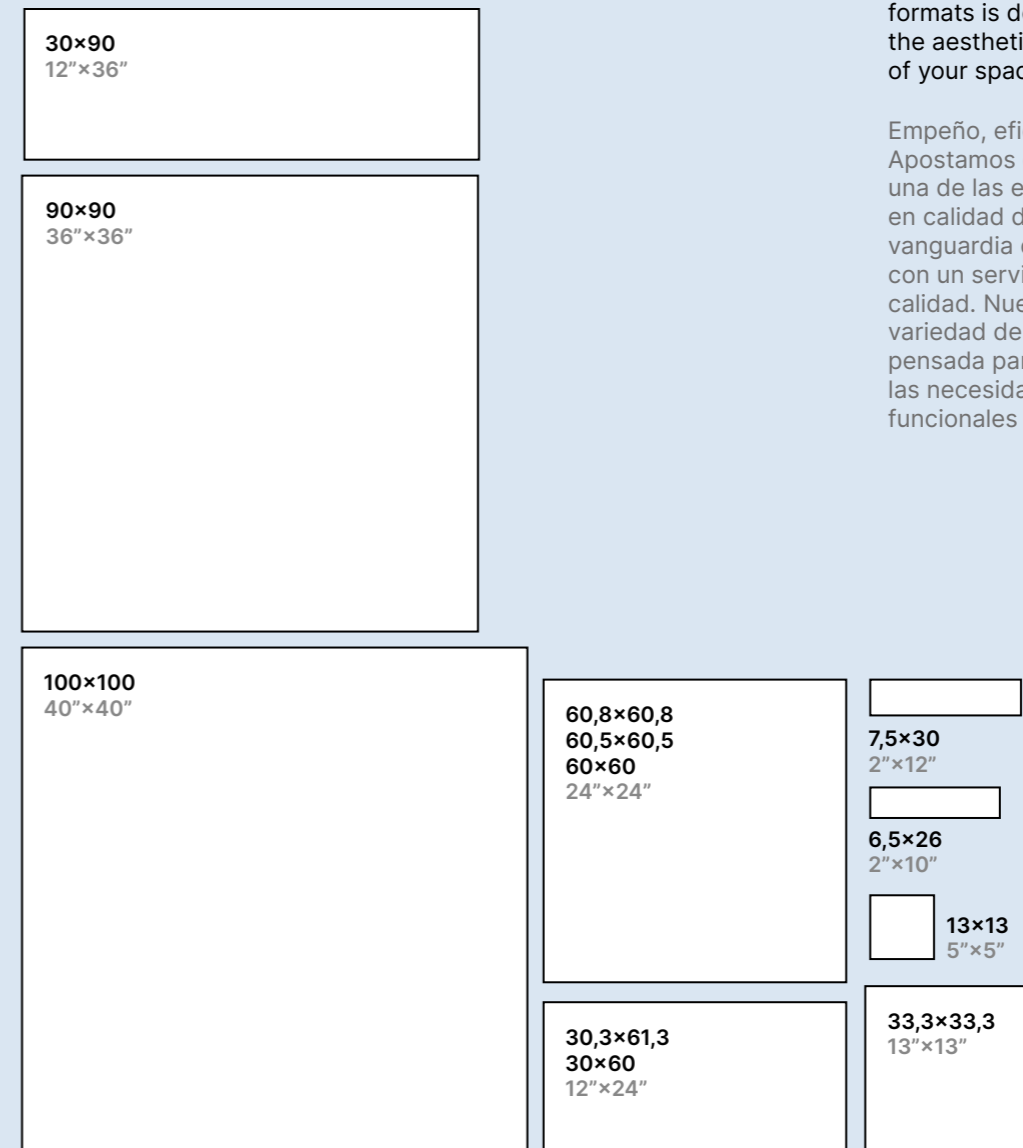

A verified
**environmental
 declaration.**
 Una **declaración
 medioambiental**
 verificada.



Our products are manufactured according to the following standards ISO 13006 in 14411 ANG.
 Nuestros productos están fabricados bajo las normativas ISO 13006 en 14411 ANG.



**HOLDER OF THE DECLARATION
 TITULAR DE LA DECLARACIÓN**



Asociación Española de Fabricantes de Azulejos y Pavimentos Cerámicos
 Ronda Circunvalación, 186 (+34) 964 34 24 24
 Avda. de Vicent Sos Baynat s/n r_medioambiente@itc.uji.es
 12006 Castellón http://www.itc.uji.es
 España

**LCA STUDY
 ESTUDIO DE LA ACV**



Instituto de Tecnología Cerámica – (ITC-AICE) (+34) 964 34 24 24
 Campus Universitario Riu Sec, r_medioambiente@itc.uji.es
 Avda. de Vicent Sos Baynat s/n http://www.itc.uji.es
 12006 Castellón
 España

**OPERATOR OF THE GLOBAL EPD PROGRAMME
 ADMINISTRADOR GLOBAL DEL PROGRAMA EPD**



AENOR Internacional S.A.U. (+34) 902 102 201
 Génova 6 aenordap@aenor.com
 28009 Madrid www.aenor.com
 España

AENOR is a founding member of ECO Platform, the European Association of Environmental Declarations verification Programmes.

AENOR es miembro fundador de ECO Platform, la Asociación de Programas de verificación de Declaraciones ambientales de producto.

	GLOBALEPD-RCP-002 REV. 2 CEN standard EN 15804:2012+A1:2013 serves as the core RCP Independent verification of the declaration and data, according to EN ISO 14025:2010	La Norma Europea EN 15804:2012+A1:2013 sirva de base para las RCP Verificación independiente de la Declaración y de los datos, de acuerdo con la norma EN ISO 14025:2010
	<input type="checkbox"/> Internal <input checked="" type="checkbox"/> External	

material materiales

V-LAM		MARBLES MÁRMOLES	
Aral	12	Andromeda	112
Jackson Blue	14	Atmosphere	116
New Spiral	16	Dust	120
Space	18	Jump	122
Star	22	Marma	126
Wood	24	Meteor	128
		Milky Way	130
		Orion	134
		Pluto	138
CEMENTS & METALS		Rocket	140
CEMENTOS Y METALES		Satellite	146
Alloy	30	Spiral	148
Aries	34	Sun	150
Century	38	Supreme	152
Cloud	42	Venus	156
Fusion	46		
Madison	50	WOODS MADERAS	
Mercury	54	Cava	162
Nebula	60	Comet	164
Rainbow	64	Matter	166
Void	66	Orbit	168
		Planet	170
		Prego	172
STONES PIEDRAS		Spark	174
Antares	72	Tropic	176
Galaxy	74	Western	178
Gravity	78	Wild	180
Icon	80		
Indo	84	COTTO COTTO	
Luxor	88	Arcadia	184
Moon	92	Cotto	190
Neptune	96	Icarus	194
Portland	100		
Purestone	104	WHITES BLANCOS	
Sismic	106	Apolo	200
		Star	202

alphabetical alfabético

Alloy	30	Moon	92
Andromeda	112	Nebula	60
Antares	72	Neptune	96
Apolo	200	New Spiral	16
Aral	12	Orbit	168
Arcadia	184	Orion	134
Aries	34	Planet	170
Atmosphere	116	Pluto	138
Cava	162	Portland	100
Century	38	Prego	172
Cloud	42	Purestone	104
Comet	164	Rainbow	64
Cotto	190	Rocket	140
Dust	120	Satellite	146
Fusion	46	Sismic	106
Galaxy	74	Space	18
Gravity	78	Spark	174
Icarus	194	Spiral	148
Icon	80	Star	22
Indo	84	Star	202
Jackson Blue	14	Sun	150
Jump	122	Supreme	152
Luxor	88	Tropic	176
Madison	50	Venus	156
Marma	126	Void	66
Matter	166	Western	178
Mercury	54	Wild	180
Meteor	128	Wood	24
Milky Way	130		

technical area área técnica

Users guide	206
Symbology	209
Technical Information	210
Mosaics	211
Skirting board, rain-gutter and steps	211

formats formatos

100×300 40"×118"	23,3×120 8"×48"	60,8×60,8 · 60,5×60,5 60×60 24"×24"	
Aral	12	Prego	172
Jackson Blue	14	Western	178
New Spiral	16		
Space	18	20×120 8"×48"	
Star	22	Cava	162
Wood	24	Comet	164
		Matter	166
		Planet	170
		Tropic	176
120×120 48"×48"	22,5×119,5 9"×47"		
Andromeda	112	Orbit	168
Jump	122		
Marma	126	100×100 40"×40"	
Spiral	148	Cloud	42
Venus	156	Galaxy	74
Void	66		
		60×120 24"×48"	
Alloy	30	90×90 36"×36"	
Andromeda	112	Aries	34
Antares	72	Atmosphere	116
Aries	34	Century	38
Atmosphere	116	Fusion	46
Century	38	Indo	84
Cloud	42	Milky Way	130
Dust	120	Nebula	60
Fusion	46	Neptune	96
Galaxy	74	Orion	134
Indo	84	Sismic	106
Jump	122		
Luxor	88	30×90 12"×36"	
Madison	50	Apolo	200
Marma	126	Galaxy	74
Mercury	54	Milky Way	130
Meteor	128	Nebula	60
Milky Way	130	Orion	134
Nebula	60	Portland	100
Neptune	96		
Orion	134	22,5×90 9"×36"	
Pluto	138	Spark	174
Rocket	140	Wild	180
Satellite	146		
Sismic	106	33,3×33,3 13"×13"	
Spiral	148	Cotto	190
Star	202		
Sun	150	7,5×30 2"×12"	
Supreme	152	Icarus	194
Venus	156		
Void	66		
		6,5×25 2"×10" 13×13 5"×5"	
		Arcadia	184

villa
ceramica

v-lam

the pure essence of large-format

The slab is the pure essence of large-format materials, it is the maximum expression of minimalism and the elegance of rooms that are almost clean of joints, getting as close as possible to noble materials. We invite you to discover our “v-lam collections”, which due to their refinement and magnitude are the perfect solution to dress up your spaces.

La placa es la esencia pura de los materiales de gran formato, es la máxima expresión del minimalismo y la elegancia de las habitaciones que están casi limpias de juntas, acercándose lo más posible a materiales nobles. Te invitamos a descubrir nuestras “colecciones v-lam”, que debido a su refinamiento y magnitud son la solución perfecta para vestir tus espacios.

Aral

PORCELAIN PORCELÁNICO

V-LAM SERIES

general book 2024

villa
cerámica

TECHNICAL FEATURES CARACTERÍSTICAS TÉCNICAS

V1 P

Aral Beige



AVAILABLE SIZES FORMATOS DISPONIBLES



FACES

RECT. 100×300 RECT. 40"×118"



3

PACKING LIST EMBALAJE

SIZE FORMATO	M ² PIECE M ² PIEZA	KG PIECE KG PIEZA	PIECES PALLET PIEZAS PALLET	M ² PALLET M ² PALLET	KG PALLET KG PALLET
RECT. 100×300	3	41,83	13	39	628

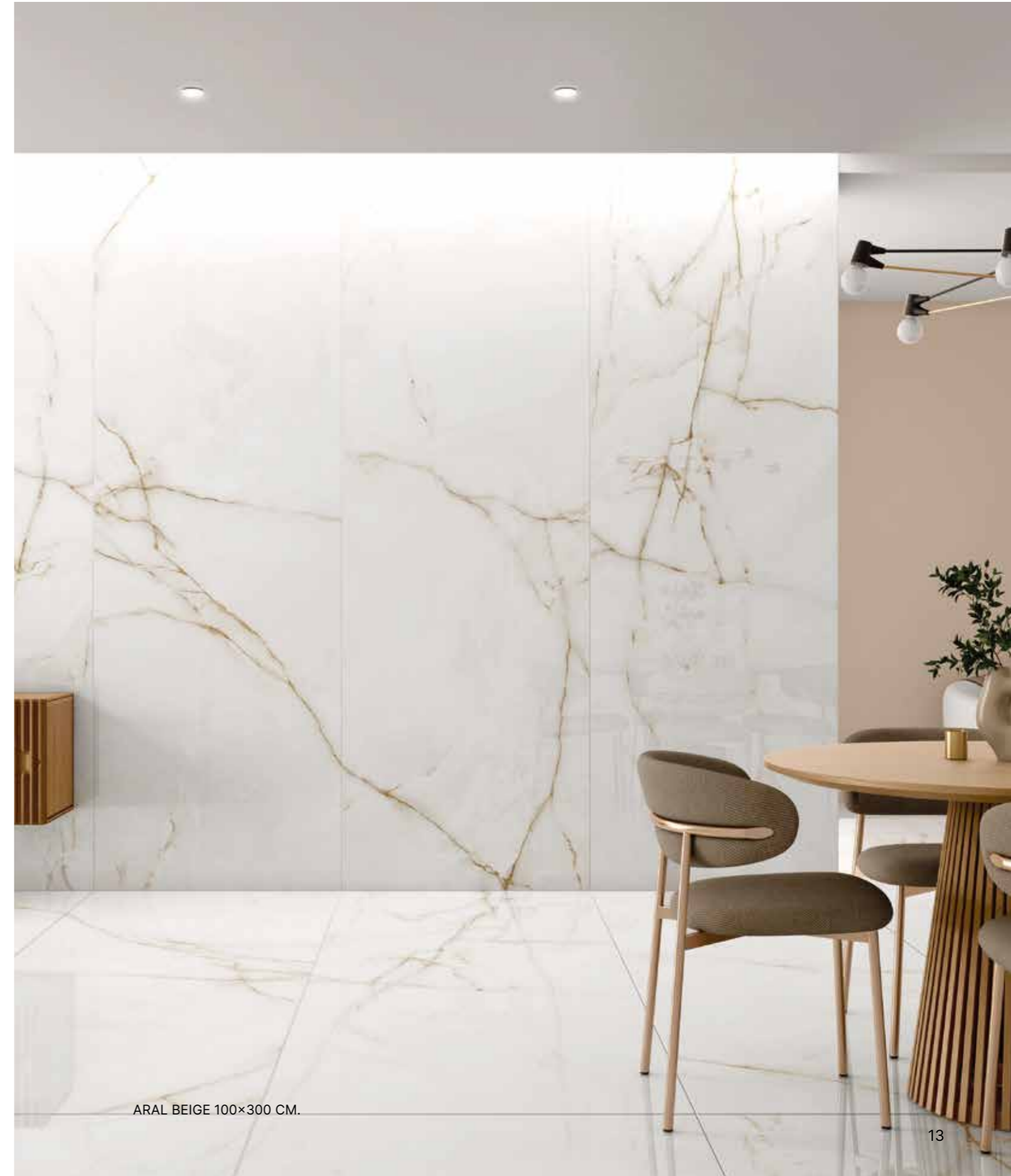

ARAL BEIGE 100×300 CM.

Jackson Blue

V-LAM SERIES

general book 2024

villa
ceramica

PORCELAIN PORCELÁNICO

TECHNICAL FEATURES CARACTERÍSTICAS TÉCNICAS

V1 P

Jackson Blue



AVAILABLE SIZES FORMATOS DISPONIBLES



FACES

RECT. 100×300 RECT. 40"×118"



3

PACKING LIST EMBALAJE

SIZE FORMATO	M ² PIECE M ² PIEZA	KG PIECE KG PIEZA	PIECES PALLET PIEZAS PALLET	M ² PALLET M ² PALLET	KG PALLET KG PALLET
RECT. 100×300	3	41,83	13	39	628

JACKSON BLUE 100×300 CM.

New Spiral

PORCELAIN PORCELÁNICO

V-LAM SERIES

general book 2024

villa
cerámica

TECHNICAL FEATURES CARACTERÍSTICAS TÉCNICAS

V1 P M

New Spiral



AVAILABLE SIZES FORMATOS DISPONIBLES



FACES

RECT. 100×300 RECT. 40"×118"



3

PACKING LIST EMBALAJE

SIZE FORMATO	M ² PIECE M ² PIEZA	KG PIECE KG PIEZA	PIECES PALLET PIEZAS PALLET	M ² PALLET M ² PALLET	KG PALLET KG PALLET
RECT. 100×300	3	41,83	13	39	628



NEW SPIRAL 100×300 CM.

Space

PORCELAIN PORCELÁNICO

V-LAM SERIES

general book 2024

villa
cerámica

TECHNICAL FEATURES CARACTERÍSTICAS TÉCNICAS

V1 P M



SPACE WHITE 100×300 CM. SPACE BLACK 100×300 CM.

Space

PORCELAIN PORCELÁNICO

V-LAM SERIES

general book 2024

villa
cerámica

TECHNICAL FEATURES CARACTERÍSTICAS TÉCNICAS

V1 P M

Space White



Space Black



AVAILABLE SIZES FORMATOS DISPONIBLES



FACES

RECT. 100×300 RECT. 40"×118"



3

PACKING LIST EMBALAJE

SIZE FORMATO	M ² PIECE M ² PIEZA	KG PIECE KG PIEZA	PIECES PALLET PIEZAS PALLET	M ² PALLET M ² PALLET	KG PALLET KG PALLET
RECT. 100×300	3	41,83	13	39	628

AVAILABLE SIZES FORMATOS DISPONIBLES



FACES

RECT. 100×300 RECT. 40"×118"



3

PACKING LIST EMBALAJE

SIZE FORMATO	M ² PIECE M ² PIEZA	KG PIECE KG PIEZA	PIECES PALLET PIEZAS PALLET	M ² PALLET M ² PALLET	KG PALLET KG PALLET
RECT. 100×300	3	41,83	13	39	628

Star

PORCELAIN PORCELÁNICO

Star

V-LAM SERIES

general book 2024

villa
cerámica

TECHNICAL FEATURES CARACTERÍSTICAS TÉCNICAS

V1 M

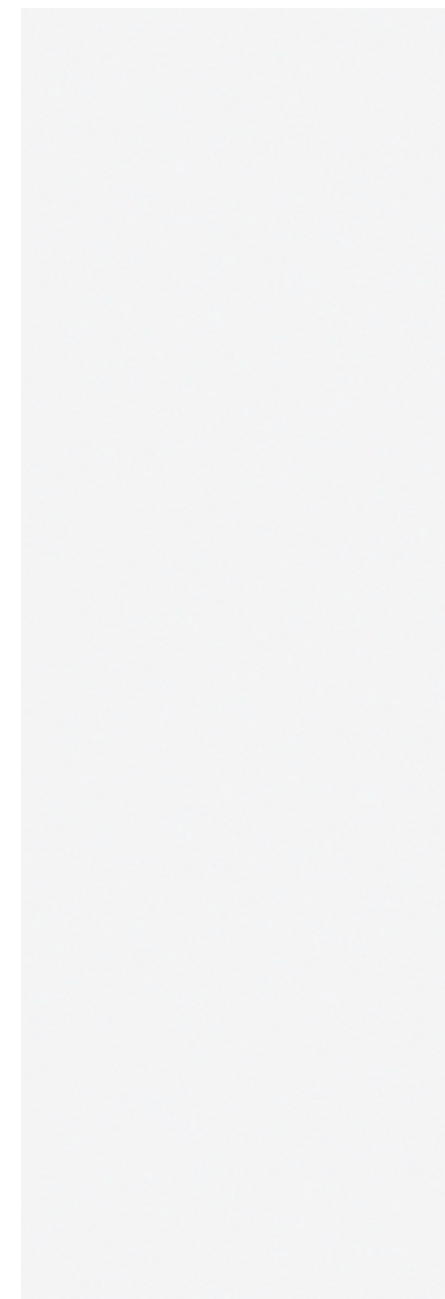

AVAILABLE SIZES FORMATOS DISPONIBLES

RECT. 100×300 RECT. 40"×118"

PACKING LIST EMBALAJE

SIZE FORMATO	M ² PIECE M ² PIEZA	KG PIECE KG PIEZA	PIECES PALLET PIEZAS PALLET	M ² PALLET M ² PALLET	KG PALLET KG PALLET
RECT. 100×300	3	41,83	13	39	628



STAR 100×300 CM.

Wood

PORCELAIN PORCELÁNICO

V-LAM SERIES

general book 2024

villa
cerámica

TECHNICAL FEATURES CARACTERÍSTICAS TÉCNICAS

V1 M

Wood Natural



AVAILABLE SIZES FORMATOS DISPONIBLES



FACES

RECT. 100×300 RECT. 40"×118"



3

PACKING LIST EMBALAJE

SIZE FORMATO	M ² PIECE M ² PIEZA	KG PIECE KG PIEZA	PIECES PALLET PIEZAS PALLET	M ² PALLET M ² PALLET	KG PALLET KG PALLET
RECT. 100×300	3	41,83	13	39	628



WOOD NATURAL 100×300 CM.

Wood

PORCELAIN PORCELÁNICO

V-LAM SERIES

general book 2024

villa
cerámica

TECHNICAL FEATURES CARACTERÍSTICAS TÉCNICAS

V1 M

Wood Nut



Wood Oak



AVAILABLE SIZES FORMATOS DISPONIBLES



FACES

RECT. 100×300 RECT. 40"×118"



3

PACKING LIST EMBALAJE

SIZE FORMATO	M ² PIECE M ² PIEZA	KG PIECE KG PIEZA	PIECES PALLET PIEZAS PALLET	M ² PALLET M ² PALLET	KG PALLET KG PALLET
RECT. 100×300	3	41,83	13	39	628

AVAILABLE SIZES FORMATOS DISPONIBLES



FACES

RECT. 100×300 RECT. 40"×118"



3

PACKING LIST EMBALAJE

SIZE FORMATO	M ² PIECE M ² PIEZA	KG PIECE KG PIEZA	PIECES PALLET PIEZAS PALLET	M ² PALLET M ² PALLET	KG PALLET KG PALLET
RECT. 100×300	3	41,83	13	39	628

cements and metals

purest materials

Cement and metal, two pure elements whose intrinsic character is part of the innate composition of original nature. With an imposing personality . Discover the essential collections inspired by the most avant-garde cements and metals and let yourself be captivated by their attractive and consistent surface.

Cemento y metal, dos elementos puros cuyo carácter intrínseco forma parte de la composición innata de la naturaleza original. De personalidad imponente y apariencia compacta. Descubre las colecciones esenciales inspiradas en los cementos y metales más vanguardistas y déjate cautivar por su atrayente y consistente superficie.

Alloy

PORCELAIN PORCELÁNICO

CEMENTS & METALS CEMENTOS Y METALES

general book 2024

villa
cerámica

TECHNICAL FEATURES CARACTERÍSTICAS TÉCNICAS

V2 L C1 R9

Alloy White

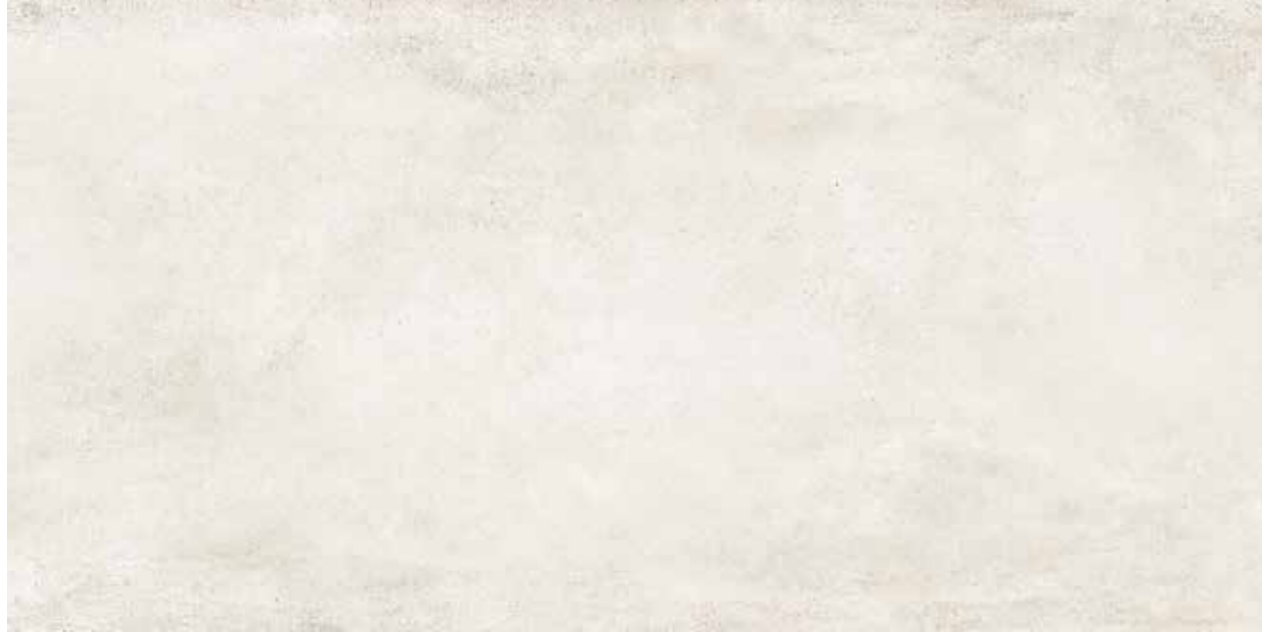

DIFFERENT GRAPHICS GRÁFICAS DIFERENTES



AVAILABLE SIZES FORMATOS DISPONIBLES

RECT. 60x120
RECT. 24"x48"



RECT. 60x120 ● ● ● ● ● 10

Mosaicos, rodapiés y peldaños disponibles bajo solicitud, ver pag. 211.
Mosaics, skirting boards and steps available on request, see page 211.

PACKING LIST EMBALAJE

SIZE FORMATO	PIECES BOX PIEZAS CAJA	M² BOX M² CAJA	KG BOX KG CAJA	BOXES CAJAS	M² PALLET M² PALLET	KG PALLET KG PALLET
RECT. 60x120	2	1,44	34,25	32	46,08	1.121

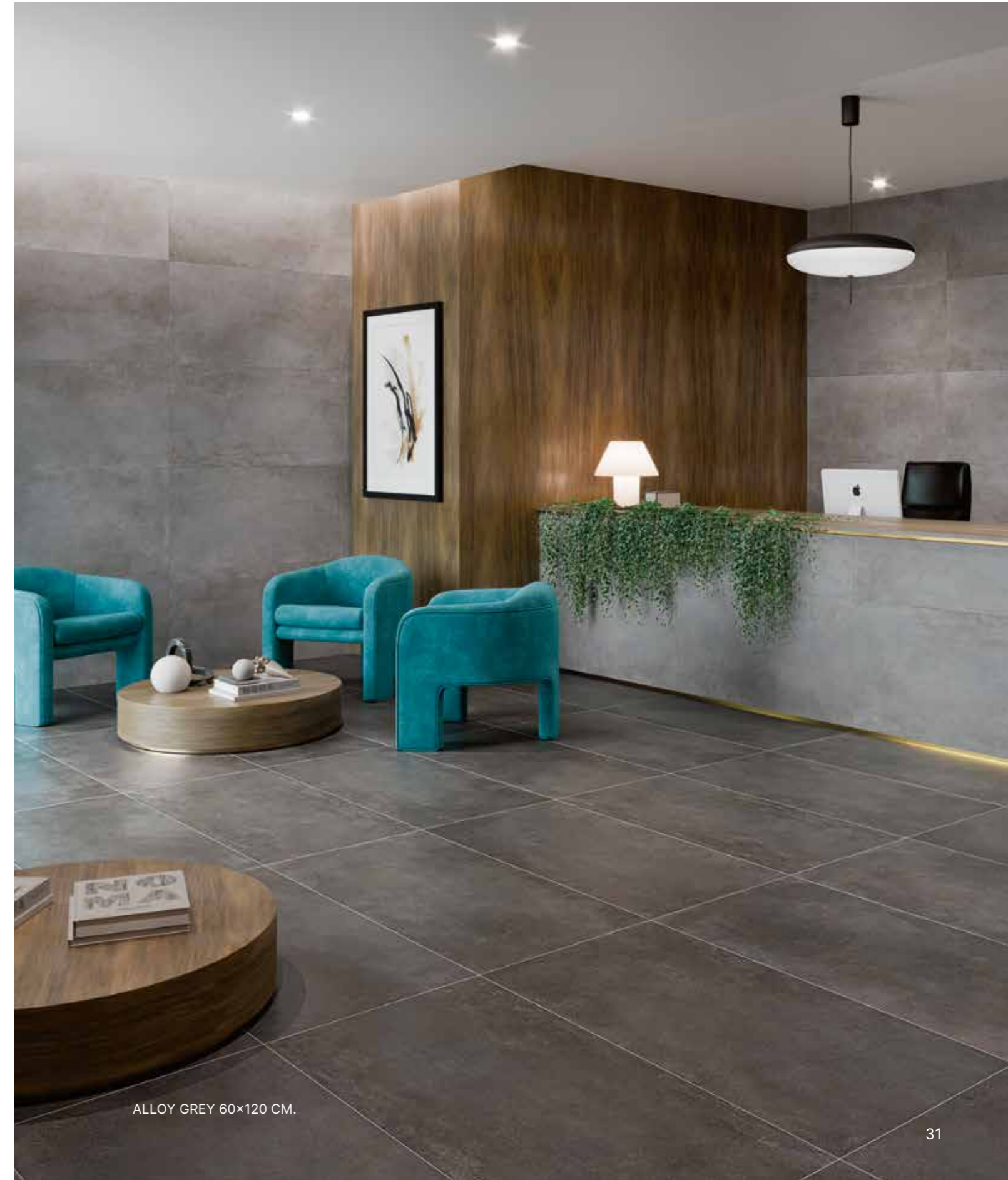

ALLOY GREY 60x120 CM.

Alloy

PORCELAIN PORCELÁNICO

CEMENTS & METALS CEMENTOS Y METALES

general book 2024

villa
cerámica

TECHNICAL FEATURES CARACTERÍSTICAS TÉCNICAS

V2 L C1 R9

Alloy Beige



Alloy Grey



Alloy Oxide



Alloy Anthracite



AVAILABLE SIZES FORMATOS DISPONIBLES

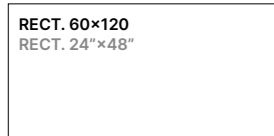

RECT. 60x120 10

Mosaicos, rodapiés y peldaños disponibles bajo solicitud, ver pag. 211.
Mosaics, skirting boards and steps available on request, see page 211.

PACKING LIST EMBALAJE

SIZE FORMATO	PIECES BOX PIEZAS CAJA	M ² BOX M ² CAJA	KG BOX KG CAJA	BOXES CAJAS	M ² PALLET M ² PALLET	KG PALLET KG PALLET
RECT. 60x120	2	1,44	34,25	32	46,08	1.121

DIFFERENT GRAPHICS GRÁFICAS DIFERENTES



Aries

COLOURED BODY PORCELAIN PORCELÁNICO MASA COLOREADA

CEMENTS & METALS CEMENTOS Y METALES

general book 2024

villa
cerámica

TECHNICAL FEATURES CARACTERÍSTICAS TÉCNICAS

V2 M H



ARIES BLACK 90x90 CM.

Aries

CEMENTS & METALS CEMENTOS Y METALES

general book 2024

villa
cerámica

COLOURED BODY PORCELAIN PORCELÁNICO MASA COLOREADA

Aries Sand





Aries Black

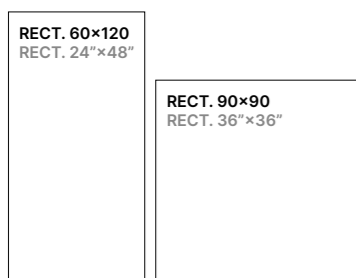

AVAILABLE SIZES FORMATOS DISPONIBLES



				FACES
RECT. 60x120	●	●	●	10
RECT. 90x90	●	●	●	10

TECHNICAL FEATURES CARACTERÍSTICAS TÉCNICAS



Aries Grey



DIFFERENT GRAPHICS GRÁFICAS DIFERENTES

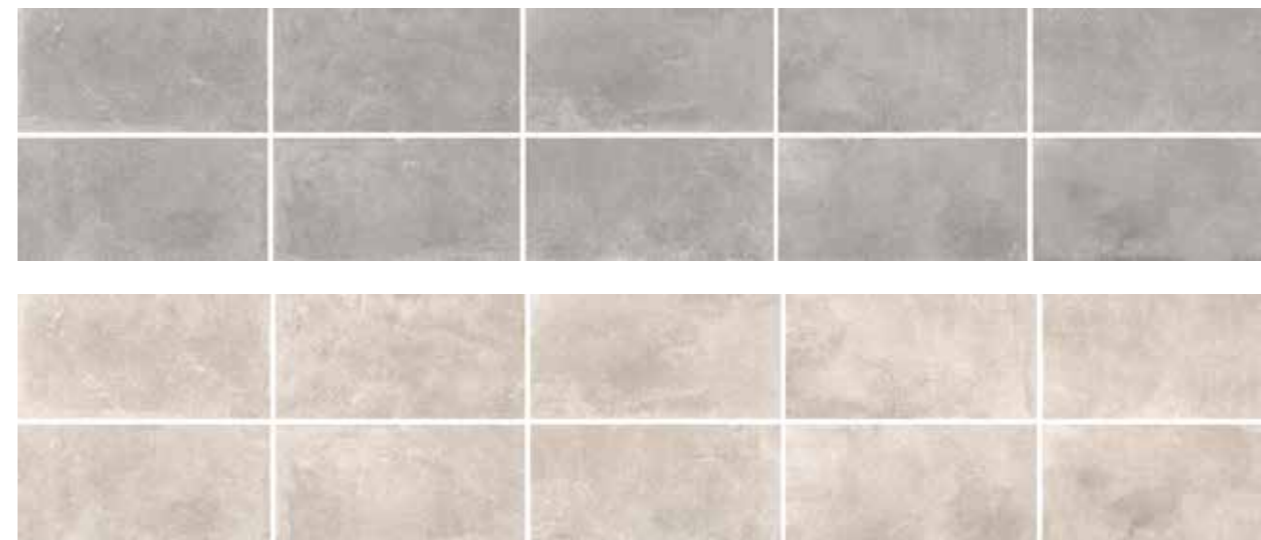

PACKING LIST EMBALAJE

Mosaicos, rodapiés y peldaños disponibles bajo solicitud, ver pag. 211.
Mosaics, skirting boards and steps available on request, see page 211.

SIZE FORMATO	PIECES BOX PIEZAS CAJA	M ² BOX M ² CAJA	KG BOX KG CAJA	BOXES CAJAS	M ² PALLET M ² PALLET	KG PALLET KG PALLET
RECT. 60x120	2	1,44	34,56	30	38,88	1.037
RECT. 90x90	2	1,62	37,6	27	43,74	1.016

Century

COLOURED BODY PORCELAIN PORCELÁNICO MASA COLOREADA

general book 2024

villa
cerámica

TECHNICAL FEATURES CARACTERÍSTICAS TÉCNICAS

V2 M C1 R9



CENTURY MARENGO 90×90 CM.

Century

CEMENTS & METALS CEMENTOS Y METALES

general book 2024

villa
cerámica

COLOURED BODY PORCELAIN PORCELÁNICO MASA COLOREADA

Century Perla





Century Marengo

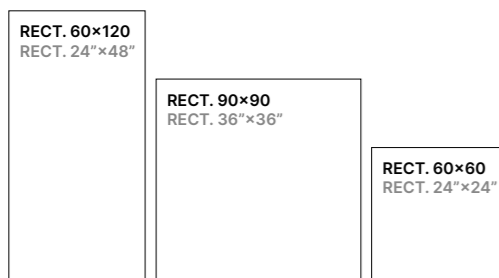

AVAILABLE SIZES FORMATOS DISPONIBLES



				FACES
RECT. 60x120	●	●	●	5
RECT. 90x90	●	●	●	12
RECT. 60x60	●	●	●	9

TECHNICAL FEATURES CARACTERÍSTICAS TÉCNICAS



Century Grey



DIFFERENT GRAPHICS GRÁFICAS DIFERENTES

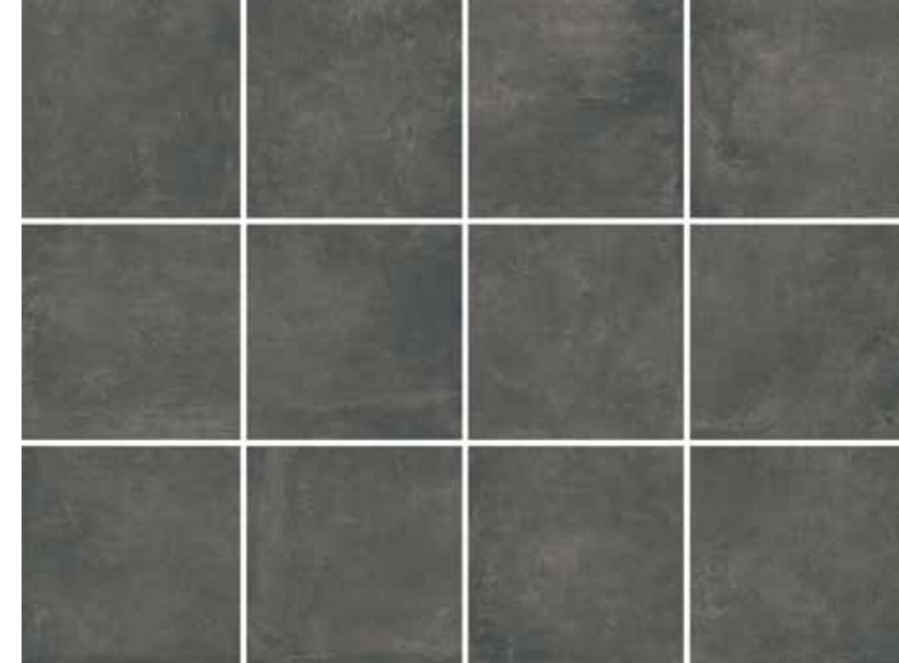

PACKING LIST EMBALAJE

Mosaicos, rodapiés y peldaños disponibles bajo solicitud, ver pag. 211.
Mosaics, skirting boards and steps available on request, see page 211.

SIZE FORMATO	PIECES BOX PIEZAS CAJA	M² BOX M² CAJA	KG BOX KG CAJA	BOXES CAJAS	M² PALLET M² PALLET	KG PALLET KG PALLET
RECT. 60x120	2	1,44	34	32	46,08	1.121
RECT. 90x90	2	1,62	40	27	43,74	1.110
RECT. 60x60	4	1,44	31,4	30	43,2	962

Cloud

PORCELAIN PORCELÁNICO

CEMENTS & METALS CEMENTOS Y METALES

general book 2024

villa
cerámica

SERIE SOLAR

TECHNICAL FEATURES CARACTERÍSTICAS TÉCNICAS

V3 M C3 R11 DCOF>0.55 PTV+36



CLOUD GREY 60,5×60,5 CM.

Cloud

PORCELAIN PORCELÁNICO

CEMENTS & METALS CEMENTOS Y METALES

general book 2024

villa
cerámica

SERIE SOLAR

TECHNICAL FEATURES CARACTERÍSTICAS TÉCNICAS

V3 **M** C3 R11 DCOF>0.55 PTV+36

Cloud White



Cloud Grey



Cloud Antracita





DIFFERENT GRAPHICS GRÁFICAS DIFERENTES

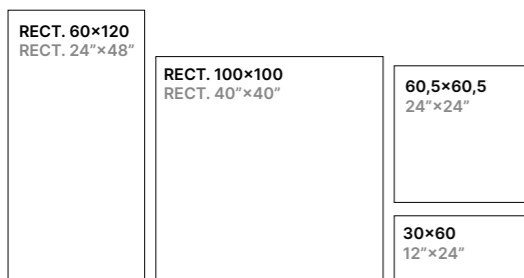

AVAILABLE SIZES FORMATOS DISPONIBLES



				FACES
RECT. 60x120	●	●	●	12
RECT. 100x100	●	●	●	8
60,5x60,5	●	●	●	12
30x60	●	●	●	24

PACKING LIST EMBALAJE

Mosaicos, rodapiés y peldaños disponibles bajo solicitud, ver pag. 211.
Mosaics, skirting boards and steps available on request, see page 211.

SIZE FORMATO	PIECES BOX PIEZAS CAJA	M ² BOX M ² CAJA	KG BOX KG CAJA	BOXES CAJAS	M ² PALLET M ² PALLET	KG PALLET KG PALLET
RECT. 60x120	2	1,44	33,3	32	46,08	991
RECT. 100x100	1	1	26	54	54	1.240
60,5x60,5	4	1,46	25,84	40	58,4	1.054
30x60	8	1,44	25,2	60	86,4	1.532

Fusion

CEMENTS & METALS CEMENTOS Y METALES

general book 2024

villa
cerámica

COLOURED BODY PORCELAIN PORCELÁNICO MASA COLOREADA

TECHNICAL FEATURES CARACTERÍSTICAS TÉCNICAS

V3 **M** C2 R10 DCOF>0.45 PTV+36

Fusion White







Fusion Grigio

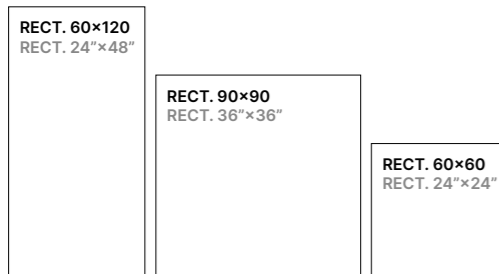

AVAILABLE SIZES FORMATOS DISPONIBLES



					FACES
RECT. 60x120	●	●	●	●	18
RECT. 90x90	●	●	●	●	15
RECT. 60x60	●	●	●	●	12

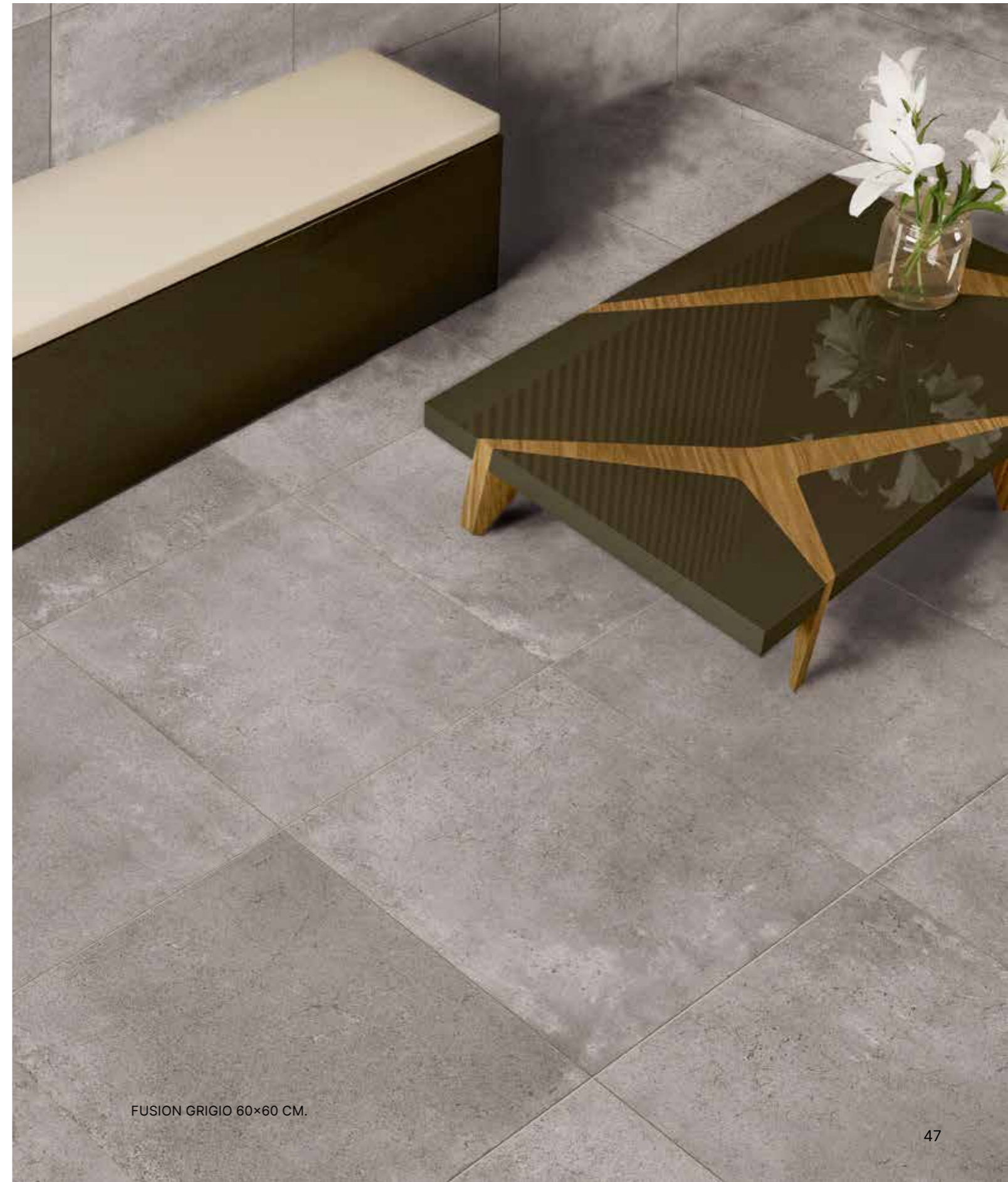

FUSION GRIGIO 60x60 CM.

Fusion

CEMENTS & METALS CEMENTOS Y METALES

general book 2024

villa
cerámica

COLOURED BODY PORCELAIN PORCELÁNICO MASA COLOREADA

Fusion Blue



Fusion Brown



TECHNICAL FEATURES CARACTERÍSTICAS TÉCNICAS

V3 M C2 R10 DCOF>0.45 PTV+36

DIFFERENT GRAPHICS GRÁFICAS DIFERENTES

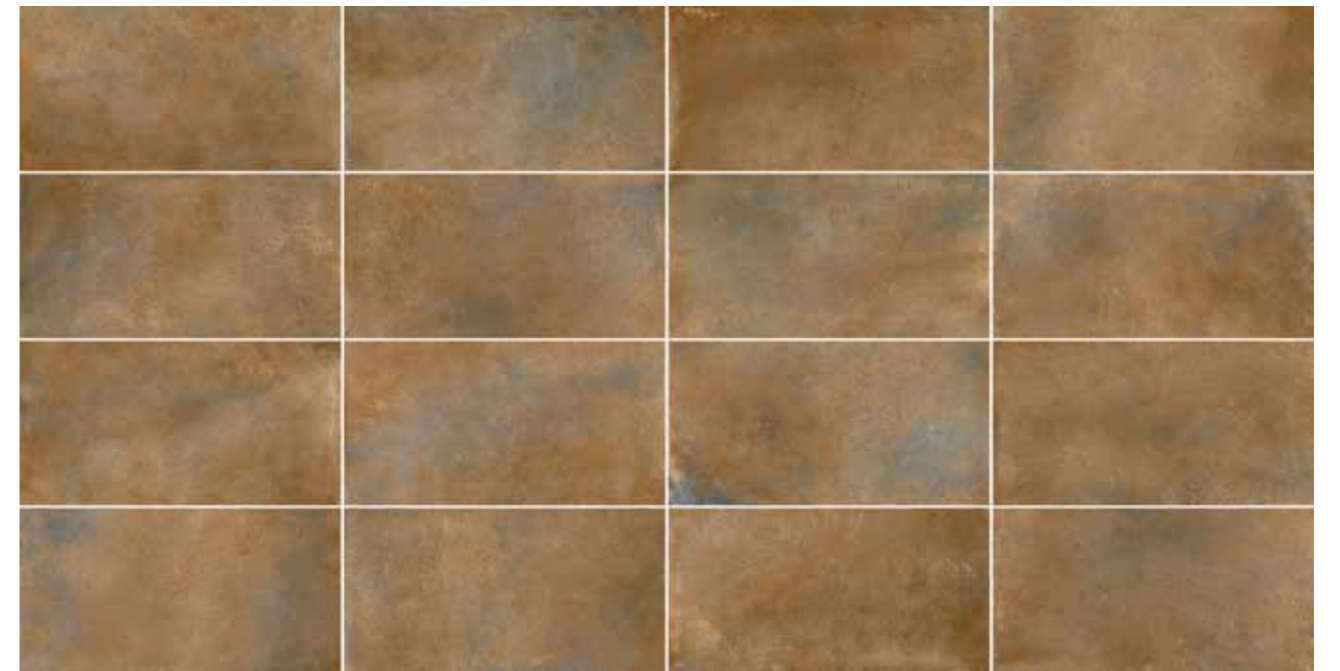

AVAILABLE SIZES FORMATOS DISPONIBLES

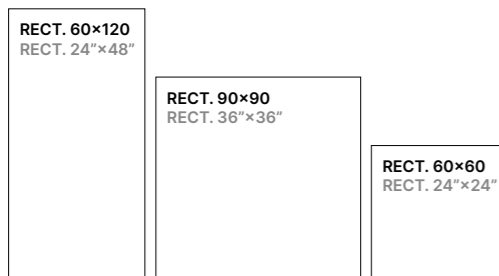

					FACES
RECT. 60x120	●	●	●	●	18
RECT. 90x90	●	●	●	●	15
RECT. 60x60	●	●	●	●	12

PACKING LIST EMBALAJE

Mosaicos, rodapiés y peldaños disponibles bajo solicitud, ver pag. 211.
Mosaics, skirting boards and steps available on request, see page 211.

SIZE FORMATO	PIECES BOX PIEZAS CAJA	M ² BOX M ² CAJA	KG BOX KG CAJA	BOXES CAJAS	M ² PALLET M ² PALLET	KG PALLET KG PALLET
RECT. 60x120	2	1,44	34,25	32	46,08	1.121
RECT. 90x90	2	1,62	40	27	43,74	1.110
RECT. 60x60	4	1,44	30	30	43,2	902

Madison

PORCELAIN PORCELÁNICO

CEMENTS & METALS CEMENTOS Y METALES

general book 2024

villa
cerámica

SERIE SOLAR

TECHNICAL FEATURES CARACTERÍSTICAS TÉCNICAS

V2 M C1 R9



MADISON GREY 60x120 CM.

Madison

PORCELAIN PORCELÁNICO

CEMENTS & METALS CEMENTOS Y METALES

general book 2024

villa
cerámica

SERIE SOLAR

TECHNICAL FEATURES CARACTERÍSTICAS TÉCNICAS

V2 **M** C1 R9

Madison Marfil



Madison Grey



Madison Perla



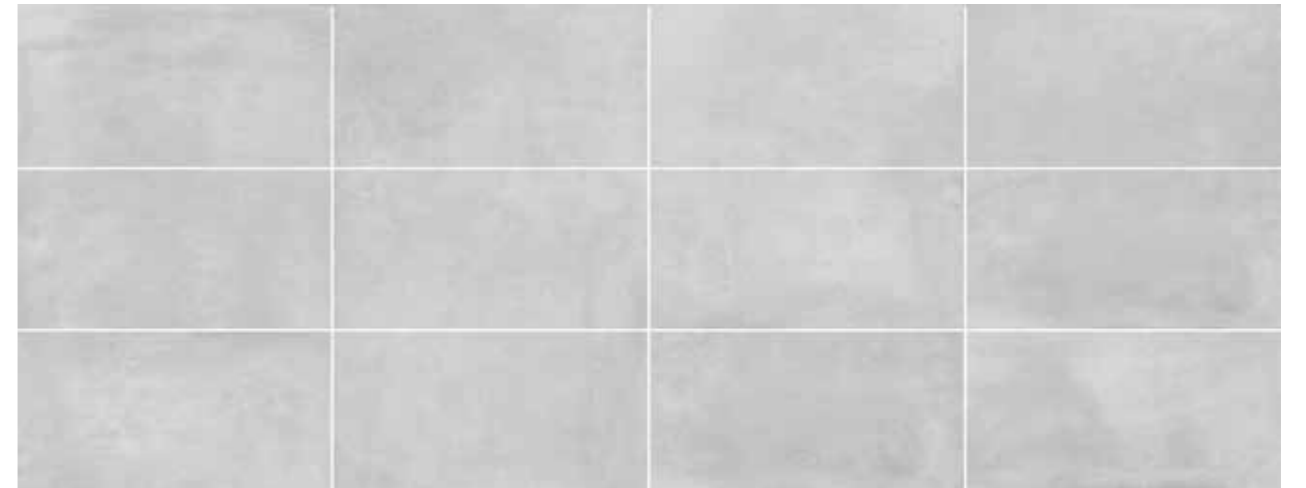

DIFFERENT GRAPHICS GRÁFICAS DIFERENTES

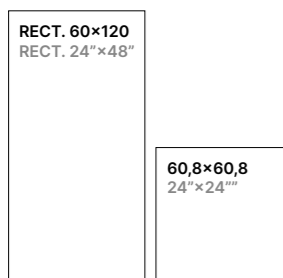

AVAILABLE SIZES FORMATOS DISPONIBLES



				FACES
RECT. 60x120	●	●	●	12
60,8x60,8	●	●	●	24

PACKING LIST EMBALAJE

Mosaicos, rodapiés y peldaños disponibles bajo solicitud, ver pag. 211.
Mosaics, skirting boards and steps available on request, see page 211.

SIZE FORMATO	PIECES BOX PIEZAS CAJA	M ² BOX M ² CAJA	KG BOX KG CAJA	BOXES CAJAS	M ² PALLET M ² PALLET	KG PALLET KG PALLET
RECT. 60x120	2	1,44	29,5	36	51,84	1.080
60,8x60,8	5	1,85	34	30	55,5	1.040

Mercury

PORCELAIN PORCELÁNICO

CEMENTS & METALS CEMENTOS Y METALES

general book 2024

villa
cerámica

SERIE SOLAR

TECHNICAL FEATURES CARACTERÍSTICAS TÉCNICAS

V1 **M** C3 R11 DCOF>0.55 PTV+36



MERCURY GREY 60x120 CM

Mercury

PORCELAIN PORCELÁNICO

CEMENTS & METALS CEMENTOS Y METALES

general book 2024

villa
cerámica

SERIE SOLAR

TECHNICAL FEATURES CARACTERÍSTICAS TÉCNICAS

V1 **M** C3 R11 DCOF>0.55 PTV+36

Mercury Light



Mercury Grey



Mercury Dark







DIFFERENT GRAPHICS GRÁFICAS DIFERENTES

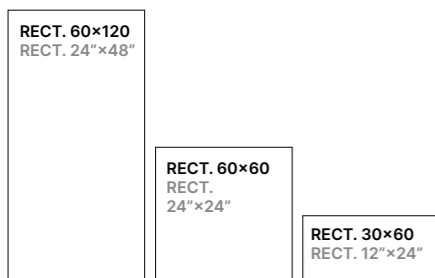

AVAILABLE SIZES FORMATOS DISPONIBLES



					FACES
RECT. 60×120	●	●	●	●	7
RECT. 60×60	●		●	●	13
RECT. 30×60	●	●	●	●	18

Mosaicos, rodapiés y peldaños disponibles bajo solicitud, ver pag. 211.
Mosaics, skirting boards and steps available on request, see page 211.

PACKING LIST EMBALAJE

SIZE FORMATO	PIECES BOX PIEZAS CAJA	M ² BOX M ² CAJA	KG BOX KG CAJA	BOXES CAJAS	M ² PALLET M ² PALLET	KG PALLET KG PALLET
RECT. 60×120	2	1,44	33,3	32	46,08	991
RECT. 60×60	4	1,44	28,1	30	43,2	862
RECT. 30×60	8	1,44	25,2	60	86,4	1.532

Mercury

PORCELAIN PORCELÁNICO

CEMENTS & METALS CEMENTOS Y METALES

general book 2024

villa
cerámica

SERIE SOLAR

TECHNICAL FEATURES CARACTERÍSTICAS TÉCNICAS

V1 M C3 R11 DCOF>0.55 PTV+36

Mercury Cream





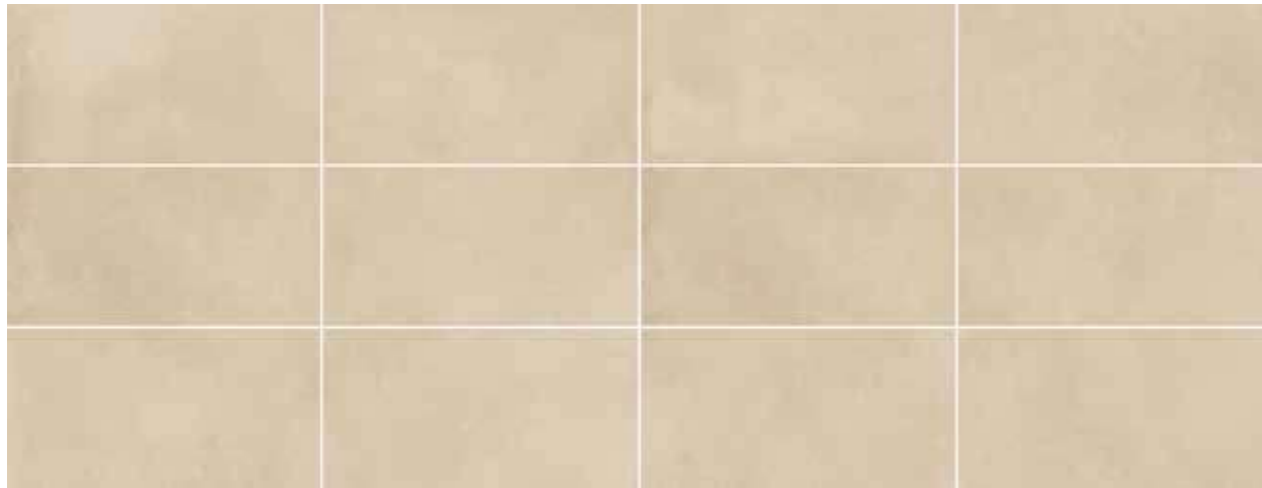

DIFFERENT GRAPHICS GRÁFICAS DIFERENTES

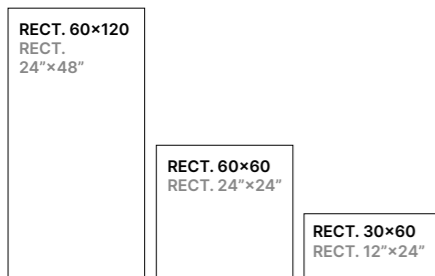

AVAILABLE SIZES FORMATOS DISPONIBLES



					FACES
RECT. 60×120	●	●	●	●	7
RECT. 60×60	●		●	●	13
RECT. 30×60	●	●	●	●	18



MERCURY CREAM 60×60 CM.

Nebula

CEMENTS & METALS CEMENTOS Y METALES

general book 2024

villa
cerámica

COLOURED BODY PORCELAIN PORCELÁNICO MASA COLOREADA
WALL TILE REVESTIMIENTO

TECHNICAL FEATURES CARACTERÍSTICAS TÉCNICAS

PORCELAIN V2 **M** C2 R10 DCOF>0.42 PTV+36

WALL TILE V2 **M**

Nebula Grey



Nebula Dark



AVAILABLE SIZES FORMATOS DISPONIBLES

PORCELAIN

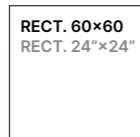
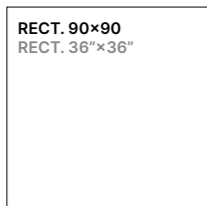
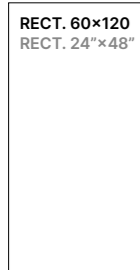

WALL TILE

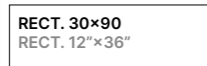

	●	●	●	●	●	●	FACES
RECT. 60x120	●	●	●	●			12
RECT. 90x90	●	●	●	●			10
RECT. 60x60	●	●	●	●			16
RECT. 30x90	●	●			●	●	15
RECT. DECOR 30x90	●	●			●	●	15



NEBULA CREAM 30x90 CM. NEBULA DECOR CREAM 30x90 CM

Nebula

CEMENTS & METALS CEMENTOS Y METALES

general book 2024

villa
cerámica

COLOURED BODY PORCELAIN PORCELÁNICO MASA COLOREADA
WALL TILE REVESTIMIENTO

TECHNICAL FEATURES CARACTERÍSTICAS TÉCNICAS

PORCELAIN V2 **M** C2 R10 DCOF>0.42 PTV+36

WALL TILE V2 **M**

Nebula Cream



Nebula Light



Decor Nebula Cream



Decor Nebula Light



DIFFERENT GRAPHICS GRÁFICAS DIFERENTES



DIFFERENT GRAPHICS GRÁFICAS DIFERENTES



AVAILABLE SIZES FORMATOS DISPONIBLES

PORCELAIN

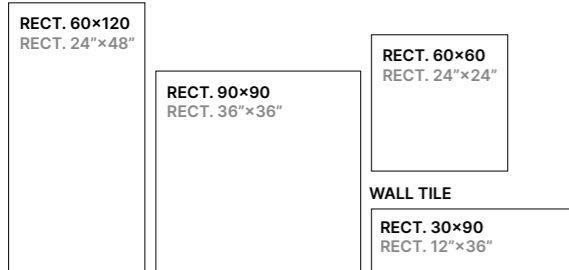

							FACES
RECT. 60x120	●	●	●	●			12
RECT. 90x90	●	●	●	●			10
RECT. 60x60	●	●	●	●			16
RECT. 30x90	●	●			●	●	15
RECT. DECOR 30x90	●	●			●	●	15

Mosaicos, rodapiés y peldaños disponibles bajo solicitud, ver pag. 211.
Mosaics, skirting boards and steps available on request, see page 211.

PACKING LIST EMBALAJE

SIZE FORMATO	PIECES BOX PIEZAS CAJA	M² BOX M² CAJA	KG BOX KG CAJA	BOXES CAJAS	M² PALLET M² PALLET	KG PALLET KG PALLET
RECT. 60x120	2	1,44	34,56	30	38,88	1.037
RECT. 90x90	2	1,62	37,6	27	43,74	1.016
RECT. 60x60	3	1,08	21,9	40	43,2	876
RECT. 30x90	4	1,08	17,96	51	55,08	916
RECT. DECOR 30x90	4	1,08	17,96	51	55,08	916

Rainbow

PORCELAIN PORCELÁNICO

CEMENTS & METALS CEMENTOS Y METALES

general book 2024

villa
cerámica

SERIE SOLAR

TECHNICAL FEATURES CARACTERÍSTICAS TÉCNICAS

V3 M C1 R9

Rainbow Perla



Rainbow Smoke



DIFFERENT GRAPHICS GRÁFICAS DIFERENTES



AVAILABLE SIZES FORMATOS DISPONIBLES

60,5×60,5
24"×24"



FACES

60,5×60,5 ● ● 7

PACKING LIST EMBALAJE

Mosaicos, rodapiés y peldaños disponibles bajo solicitud, ver pag. 211.
Mosaics, skirting boards and steps available on request, see page 211.

SIZE FORMATO	PIECES BOX PIEZAS CAJA	M² BOX M² CAJA	KG BOX KG CAJA	BOXES CAJAS	M² PALLET M² PALLET	KG PALLET KG PALLET
60,5×60,5	4	1,46	25,84	40	58,4	1.054



RAINBOW SMOKE 60,5×60,5 CM.

Void

PORCELAIN PORCELÁNICO

CEMENTS & METALS CEMENTOS Y METALES

general book 2024

villa
cerámica

TECHNICAL FEATURES CARACTERÍSTICAS TÉCNICAS

V1 M C1 R9

Void Beige



Void Grey



AVAILABLE SIZES FORMATOS DISPONIBLES

RECT. 120x120 RECT. 48"x48"	RECT. 60x120 RECT. 24"x48"	RECT. 60x60 RECT. 24"x24"
--------------------------------	-------------------------------	------------------------------

	●	●	●	●	FACES
RECT. 120x120	●	●	●	●	6
RECT. 60x120	●	●	●	●	12
RECT. 60x60	●	●	●	●	24



VOID GREY 60x120 CM.

Void

PORCELAIN PORCELÁNICO

CEMENTS & METALS CEMENTOS Y METALES

general book 2024

villa
cerámica

Void White



Void Black



TECHNICAL FEATURES CARACTERÍSTICAS TÉCNICAS



DIFFERENT GRAPHICS GRÁFICAS DIFERENTES

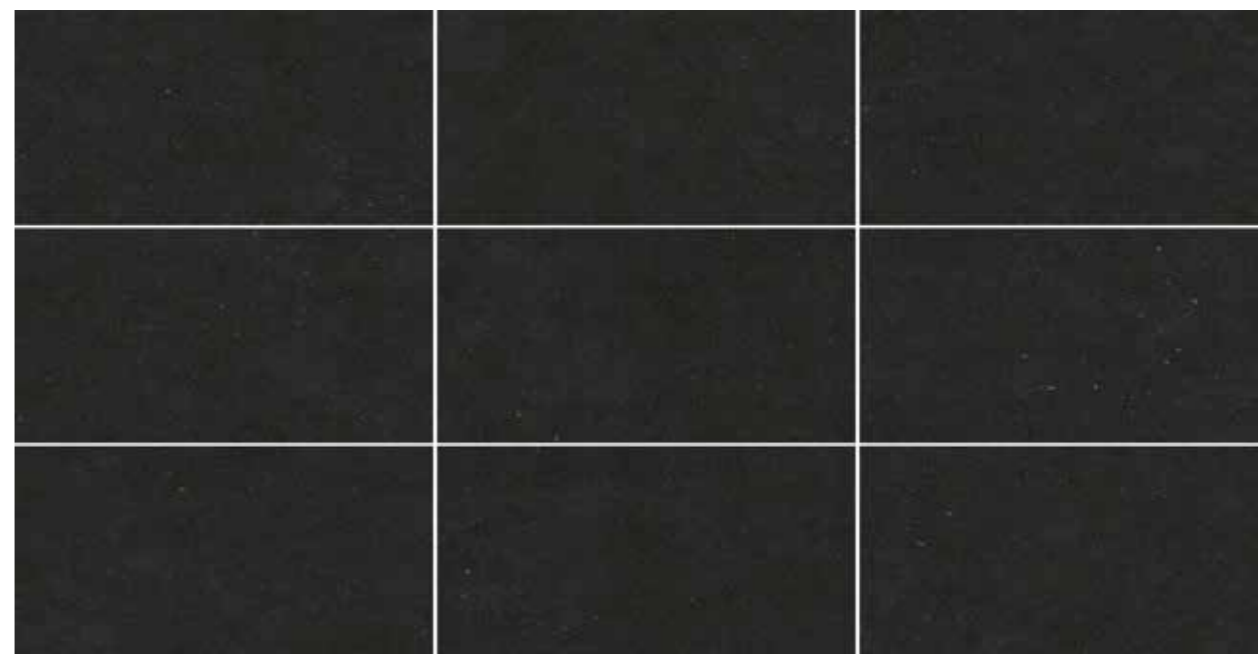
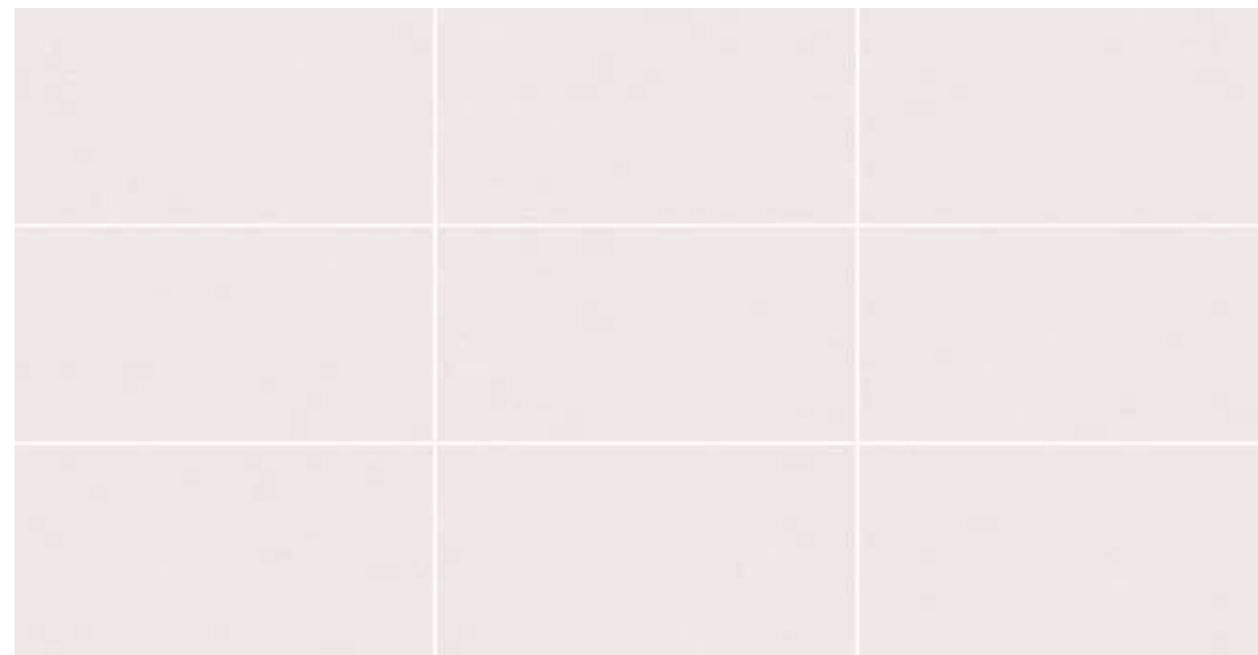

AVAILABLE SIZES FORMATOS DISPONIBLES

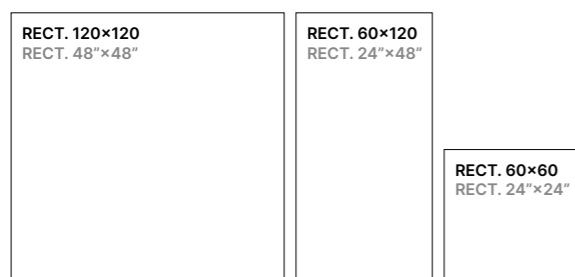

					FACES
RECT. 120x120	●	●	●	●	6
RECT. 60x120	●	●	●	●	12
RECT. 60x60	●	●	●	●	24

PACKING LIST EMBALAJE

Mosaicos, rodapiés y peldaños disponibles bajo solicitud, ver pag. 211.
Mosaics, skirting boards and steps available on request, see page 211.

SIZE FORMATO	PIECES BOX PIEZAS CAJA	M ² BOX M ² CAJA	KG BOX KG CAJA	BOXES CAJAS	M ² PALLET M ² PALLET	KG PALLET KG PALLET
RECT. 120x120	1	1,44	36,36	36	51,84	1.349
RECT. 60x120	2	1,44	34,25	32	46,08	1.121
RECT. 60x60	4	1,44	30	30	43,2	920

stones

symbol of the enduring

Stone, symbol of the enduring, the imperishable. Characterised by their hardness, robustness and durability, these materials have been a symbol of strength and unity. Distinguished in character, they are capable of captivating you through their attractive shapes and solid character. Discover pieces inspired by the purest and most authentic stones.

La piedra, símbolo de lo perdurable, lo imperecedero. Caracterizadas por su dureza, robustez y durabilidad, estos materiales han sido símbolo de fuerza y unidad. De carácter distinguido, son capaces de cautivarte a través de sus atrayentes formas y sólido carácter. Descubre las piezas inspiradas en las piedras más puras y auténticas.

Antares

PORCELAIN PORCELÁNICO

STONES PIEDRAS

general book 2024

villa
cerámica

TECHNICAL FEATURES CARACTERÍSTICAS TÉCNICAS

V1 P/S H/P M/S

Antares



DIFFERENT GRAPHICS GRÁFICAS DIFERENTES



AVAILABLE SIZES FORMATOS DISPONIBLES

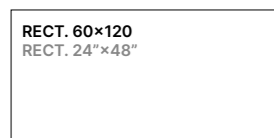

FACES

RECT. 60x120 8

PACKING LIST EMBALAJE

SIZE FORMATO	PIECES BOX PIEZAS CAJA	M ² BOX M ² CAJA	KG BOX KG CAJA	BOXES CAJAS	M ² PALLET M ² PALLET	KG PALLET KG PALLET
RECT. 60x120	2	1,44	34,56	30	38,88	1.037

Mosaicos, rodapiés y peldaños disponibles bajo solicitud, ver pag. 211.
Mosaics, skirting boards and steps available on request, see page 211.



ANTARES 60x120 CM.

Galaxy

PORCELAIN PORCELÁNICO
WALL TILE REVESTIMIENTO

STONES PIEDRAS

general book 2024

villa
cerámica

TECHNICAL FEATURES CARACTERÍSTICAS TÉCNICAS

PORCELAIN **V2** **M** WALL TILE **V2** **M**



GALAXY PEARL 30×90 CM. GALAXY GREY 30×90 CM. GALAXY DECOR GREY 30×90 CM.
GALAXY GREY 60×120 CM.

Galaxy

STONES PIEDRAS

general book 2024

villa
cerámica

PORCELAIN PORCELÁNICO
WALL TILE REVESTIMIENTO

TECHNICAL FEATURES CARACTERÍSTICAS TÉCNICAS

PORCELAIN **V2** **M** WALL TILE **V2** **M**

Galaxy Pearl



Galaxy Grey



Decor Galaxy Pearl



Decor Galaxy Grey



DIFFERENT GRAPHICS GRÁFICAS DIFERENTES

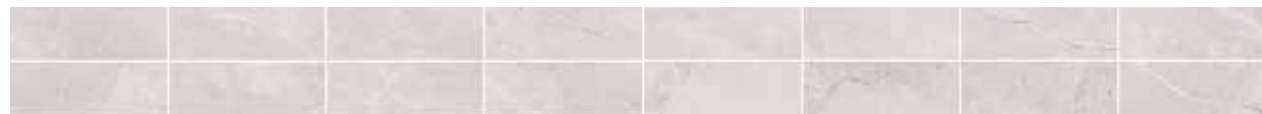

DIFFERENT GRAPHICS GRÁFICAS DIFERENTES

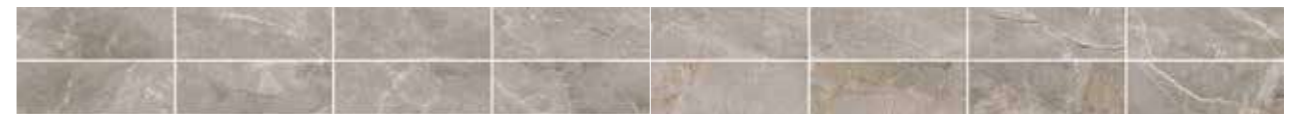

AVAILABLE SIZES FORMATOS DISPONIBLES

PORCELAIN

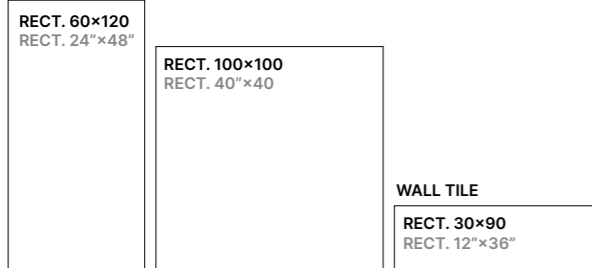

					FACES
RECT. 60x120	●	●			12
RECT. 100x100	●	●			6
RECT. 30x90	●	●			22
RECT. DECOR 30x90			●	●	22

PACKING LIST EMBALAJE

Mosaicos, rodapiés y peldaños disponibles bajo solicitud, ver pag. 211.
Mosaics, skirting boards and steps available on request, see page 211.

SIZE FORMATO	PIECES BOX PIEZAS CAJA	M ² BOX M ² CAJA	KG BOX KG CAJA	BOXES CAJAS	M ² PALLET M ² PALLET	KG PALLET KG PALLET
RECT. 60x120	2	1,44	31,5	32	46,08	991
RECT. 100x100	1	1	26	54	54	1.240
RECT. 30x90	5	1,35	19,04	64	86,4	1.330
RECT. DECOR 30x90	4	1,08	19	64	69,12	1.236

Gravity

PORCELAIN PORCELÁNICO

STONES PIEDRAS

general book 2024

villa
cerámica

TECHNICAL FEATURES CARACTERÍSTICAS TÉCNICAS

V3 M C3 R11 DCOF>0.42 PTV+36

Gravity Emerald

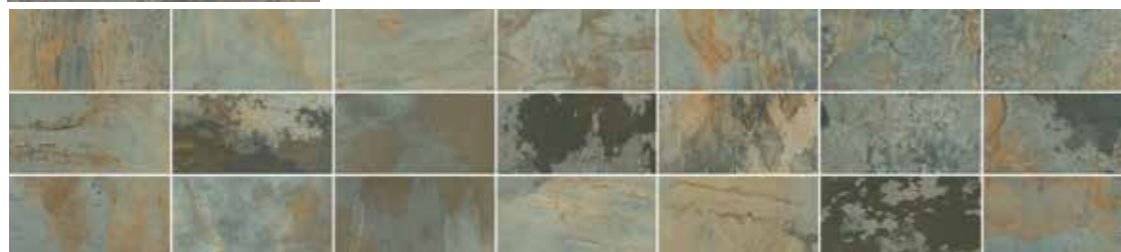

Gravity Slate

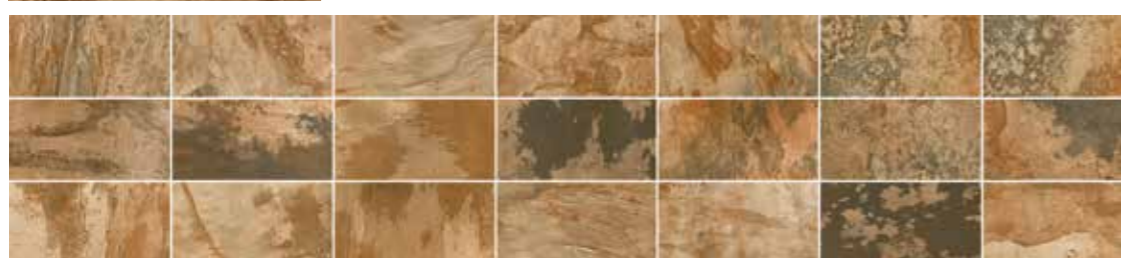

Gravity Sky



AVAILABLE SIZES FORMATOS DISPONIBLES

30×60
12"×24"



FACES

30×60 ● ● ● 22

PACKING LIST EMBALAJE

SIZE FORMATO	PIECES BOX PIEZAS CAJA	M² BOX M² CAJA	KG BOX KG CAJA	BOXES CAJAS	M² PALLET M² PALLET	KG PALLET KG PALLET
30×60	6	1,08	22,5	48	51,84	1.080

Mosaicos, rodapiés y peldaños disponibles bajo solicitud, ver pag. 211.
Mosaics, skirting boards and steps available on request, see page 211.



GRAVITY EMERALD 30×60 CM.

Icon

PORCELAIN PORCELÁNICO

STONES PIEDRAS

general book 2024

villa
cerámica

SERIE SOLAR

TECHNICAL FEATURES CARACTERÍSTICAS TÉCNICAS

V3 **M** C3 R11 DCOF>0.42 PTV+36



ICON SILVER 60,8×60,8 CM.

Icon

PORCELAIN PORCELÁNICO

STONES PIEDRAS

general book 2024

villa
cerámica

SERIE SOLAR

TECHNICAL FEATURES CARACTERÍSTICAS TÉCNICAS

V3 **M** C3 R11 DCOF>0.42 PTV+36

Icon Silver



DIFFERENT GRAPHICS GRÁFICAS DIFERENTES



Icon Gigrio



Icon Stone



DIFFERENT GRAPHICS GRÁFICAS DIFERENTES







Icon Noce



AVAILABLE SIZES FORMATOS DISPONIBLES

60,8×60,8 24"×24"	30,3×61,3 12"×24"
----------------------	----------------------

					FACES
60,8×60,8	●	●	●	●	10
30,3×61,3	●	●	●	●	20

PACKING LIST EMBALAJE

Mosaicos, rodapiés y peldaños disponibles bajo solicitud, ver pag. 211.
Mosaics, skirting boards and steps available on request, see page 211.

SIZE FORMATO	PIECES BOX PIEZAS CAJA	M ² BOX M ² CAJA	KG BOX KG CAJA	BOXES CAJAS	M ² PALLET M ² PALLET	KG PALLET KG PALLET
60,8×60,8	4	1,48	31,3	30	44,4	960
30,3×61,3	7	1,3	25	40	52	1.020

COLOURED BODY PORCELAIN PORCELÁNICO MASA COLOREADA

TECHNICAL FEATURES CARACTERÍSTICAS TÉCNICAS

V3 M C2 R10 DCOF>0.45 PTV+36

Indo Silver



Indo Mud



AVAILABLE SIZES FORMATOS DISPONIBLES

RECT. 60x120 RECT. 24"x48"	RECT. 90x90 RECT. 36"x36"	RECT. 30x60 RECT. 12"x24"
	RECT. 60x60 RECT. 24"x24"	

					FACES
RECT. 60x120	●	●	●	●	23
RECT. 90x90	●	●	●	●	11
RECT. 60x60	●	●	●	●	30
RECT. 30x60	●	●	●	●	60



INDO SILVER 60x120 CM.

Indo

STONES PIEDRAS

general book 2024

villa
cerámica

COLOURED BODY PORCELAIN PORCELÁNICO MASA COLOREADA

TECHNICAL FEATURES CARACTERÍSTICAS TÉCNICAS

V3 **M** C2 R10 DCOF>0.45 PTV+36

Indo Light



DIFFERENT GRAPHICS GRÁFICAS DIFERENTES



Indo Argent



AVAILABLE SIZES FORMATOS DISPONIBLES

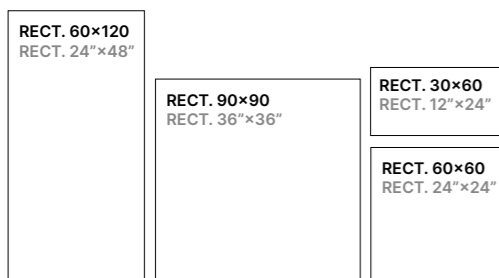

					FACES
RECT. 60x120	●	●	●	●	23
RECT. 90x90	●	●	●	●	11
RECT. 60x60	●	●	●	●	30
RECT. 30x60	●	●	●	●	60

PACKING LIST EMBALAJE

Mosaicos, rodapiés y peldaños disponibles bajo solicitud, ver pag. 211.
Mosaics, skirting boards and steps available on request, see page 211.

SIZE FORMATO	PIECES BOX PIEZAS CAJA	M ² BOX M ² CAJA	KG BOX KG CAJA	BOXES CAJAS	M ² PALLET M ² PALLET	KG PALLET KG PALLET
RECT. 60x120	2	1,44	34,5	32	46,08	1.129
RECT. 90x90	2	1,62	40	27	43,74	1.110
RECT. 60x60	4	1,44	30	30	43,2	905
RECT. 30x60	6	1,08	22	48	51,84	1.062

Luxor

STONES PIEDRAS

general book 2024

villa
cerámica

COLOURED BODY PORCELAIN PORCELÁNICO MASA COLOREADA

TECHNICAL FEATURES CARACTERÍSTICAS TÉCNICAS

V2 M C2 R10 DCOF>0.42 PTV25-35

Luxor White







Luxor Concrete

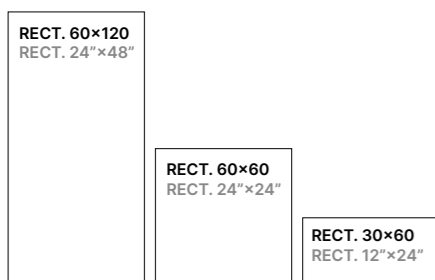

AVAILABLE SIZES FORMATOS DISPONIBLES



					FACES
RECT. 60x120	●	●	●	●	16
RECT. 60x60	●	●	●	●	32
RECT. 30x60	●	●	●	●	64



LUXOR CONCRETE 60x60 CM.

Luxor

STONES PIEDRAS

general book 2024

villa
cerámica

COLOURED BODY PORCELAIN PORCELÁNICO MASA COLOREADA

TECHNICAL FEATURES CARACTERÍSTICAS TÉCNICAS

V2 M C2 R10 DCOF>0.42 PTV25-35

Luxor Calm



DIFFERENT GRAPHICS GRÁFICAS DIFERENTES

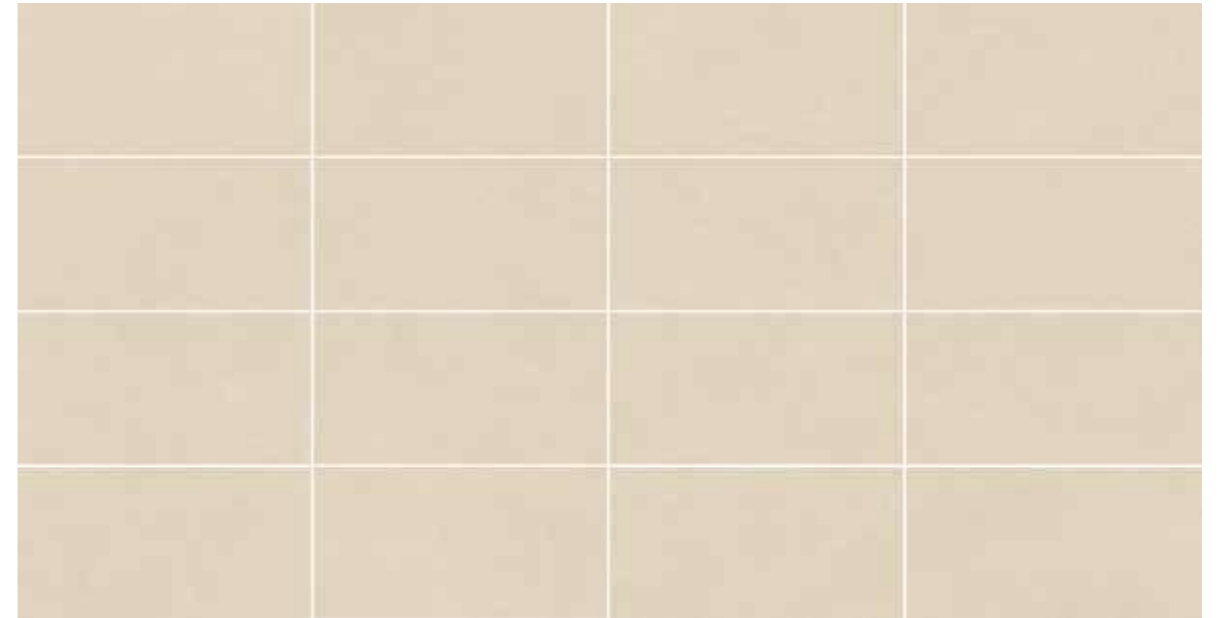



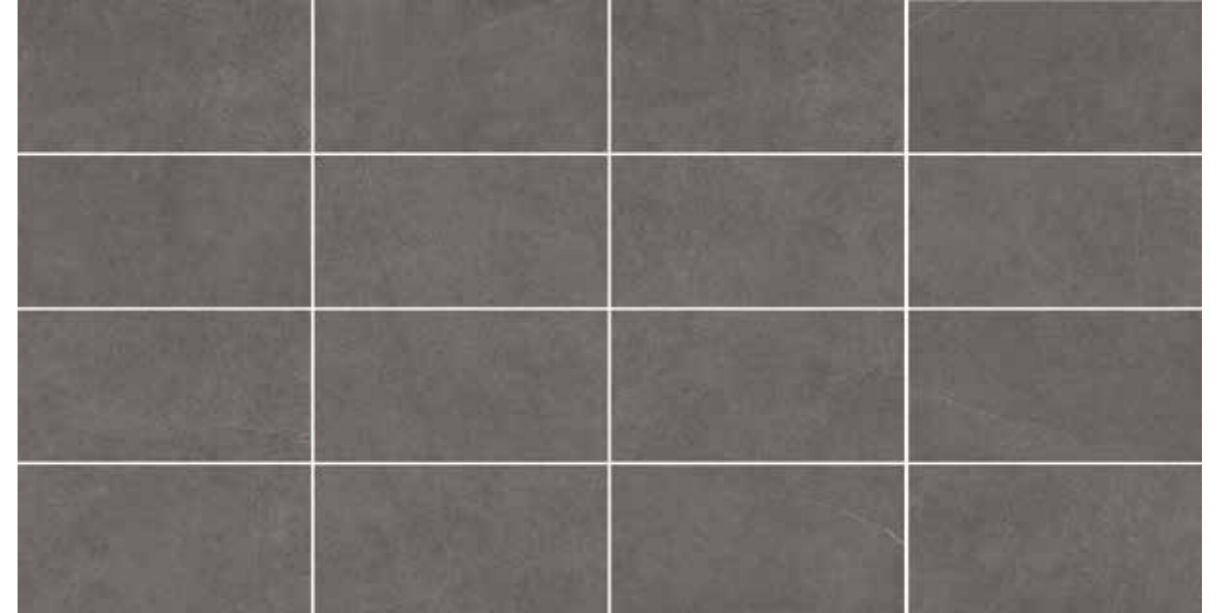

Luxor Plumb

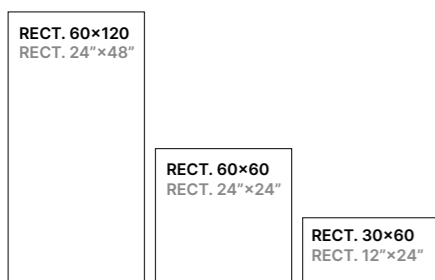

AVAILABLE SIZES FORMATOS DISPONIBLES



					FACES
RECT. 60x120	●	●	●	●	16
RECT. 60x60	●	●	●	●	32
RECT. 30x60	●	●	●	●	64

PACKING LIST EMBALAJE

Mosaicos, rodapiés y peldaños disponibles bajo solicitud, ver pag. 211.
Mosaics, skirting boards and steps available on request, see page 211.

SIZE FORMATO	PIECES BOX PIEZAS CAJA	M ² BOX M ² CAJA	KG BOX KG CAJA	BOXES CAJAS	M ² PALLET M ² PALLET	KG PALLET KG PALLET
RECT. 60x120	2	1,44	28	36	51,84	1.092
RECT. 60x60	4	1,44	27	32	46,08	950
RECT. 30x60	8	1,44	24	48	69,12	1.114

Moon

PORCELAIN PORCELÁNICO

STONES PIEDRAS

general book 2024

villa
cerámica

SERIE SOLAR

TECHNICAL FEATURES CARACTERÍSTICAS TÉCNICAS

V3 **M** C2 R10 DCOF>0.42 PTV+36



MOON WHITE 60×60 CM. MURETO MIX 30×60 CM.

Moon

PORCELAIN PORCELÁNICO

STONES PIEDRAS

SERIE SOLAR

general book 2024

villa
cerámica

TECHNICAL FEATURES CARACTERÍSTICAS TÉCNICAS

V3 **M** C2 R10 DCOF>0.42 PTV+36

DIFFERENT GRAPHICS GRÁFICAS DIFERENTES

Moon White



Moon Perla



Moon Grey



Mureto Mix



AVAILABLE SIZES FORMATOS DISPONIBLES

RECT. 60x60
RECT. 24"x24"

30x60
12"x24"



FACES

RECT. 60x60	●	●	●	●	8
30x60	●	●	●	●	15
MURETO 30x60				●	3

Mosaicos, rodapiés y peldaños disponibles bajo solicitud, ver pag. 211.
Mosaics, skirting boards and steps available on request, see page 211.

PACKING LIST EMBALAJE

SIZE FORMATO	PIECES BOX PIEZAS CAJA	M² BOX M² CAJA	KG BOX KG CAJA	BOXES CAJAS	M² PALLET M² PALLET	KG PALLET KG PALLET
RECT. 60x60	4	1,44	28,1	30	43,2	862
30x60	8	1,44	26,64	60	86,4	1.618
MURETO 30x60	8	1,44	26,64	60	86,4	1.618

Neptune

COLOURED BODY PORCELAIN PORCELÁNICO MASA COLOREADA

STONES PIEDRAS

general book 2024

villa
cerámica

TECHNICAL FEATURES CARACTERÍSTICAS TÉCNICAS

V2 **M H** 60×120 **M H** 90×90 **M** 60×60 C2 R10 DCOF>0.42 PTV+36



NEPTUNE ANTRACITE 60×120 CM.

Neptune

STONES PIEDRAS

general book 2024

villa
cerámica

COLOURED BODY PORCELAIN PORCELÁNICO MASA COLOREADA

TECHNICAL FEATURES CARACTERÍSTICAS TÉCNICAS

V2 **MH** 60×120 **MH** 90×90 **M** 60×60 C2 R10 DCOF>0.42 PTV+36

Neptune Sand



Neptune Antracite



Neptune Grey





DIFFERENT GRAPHICS GRÁFICAS DIFERENTES

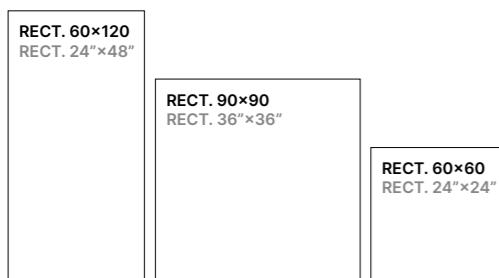

AVAILABLE SIZES FORMATOS DISPONIBLES



				FACES
RECT. 60×120	●	●	●	18
RECT. 90×90	●	●	●	11
RECT. 60×60	●	●	●	9

PACKING LIST EMBALAJE

Mosaicos, rodapiés y peldaños disponibles bajo solicitud, ver pag. 211.
Mosaics, skirting boards and steps available on request, see page 211.

SIZE FORMATO	PIECES BOX PIEZAS CAJA	M² BOX M² CAJA	KG BOX KG CAJA	BOXES CAJAS	M² PALLET M² PALLET	KG PALLET KG PALLET
RECT. 60×120	2	1,44	34,56	30	38,88	1.037
RECT. 90×90	2	1,62	37,6	27	43,74	1.016
RECT. 60×60	3	1,08	21,9	40	43,2	876

Portland

PORCELAIN PORCELÁNICO
WALL TILE REVESTIMIENTO

STONES PIEDRAS

general book 2024

villa
cerámica

TECHNICAL FEATURES CARACTERÍSTICAS TÉCNICAS

PORCELAIN V1 M C1 R9 WALL TILE M



PORTLAND WHITE 60×60 CM. PORTLAND WHITE 30×90 CM. PORTLAND DECOR WHITE 30×90 CM.

Portland

STONES PIEDRAS

general book 2024

villa
ceramica

PORCELAIN PORCELÁNICO
WALL TILE REVESTIMIENTO

Portland White



Decor Portland White



DIFFERENT GRAPHICS GRÁFICAS DIFERENTES

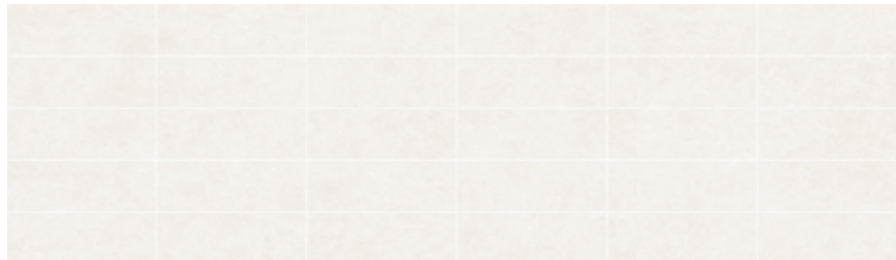

AVAILABLE SIZES FORMATOS DISPONIBLES

PORCELAIN

RECT. 60x60
RECT. 24"x24"

WALL TILE

RECT. 30x90
RECT. 12"x36"



FACES

SIZE	PIECES BOX	M ² BOX	KG BOX	BOXES	M ² PALLET	KG PALLET
RECT. 60x60	● ●	18				
RECT. 30x90	● ●	30				
RECT. DECOR 30x90	● ●	30				

TECHNICAL FEATURES CARACTERÍSTICAS TÉCNICAS

PORCELAIN

V1

M

C1

R9

WALL TILE

M

Portland Beige



Decor Portland Beige



DIFFERENT GRAPHICS GRÁFICAS DIFERENTES

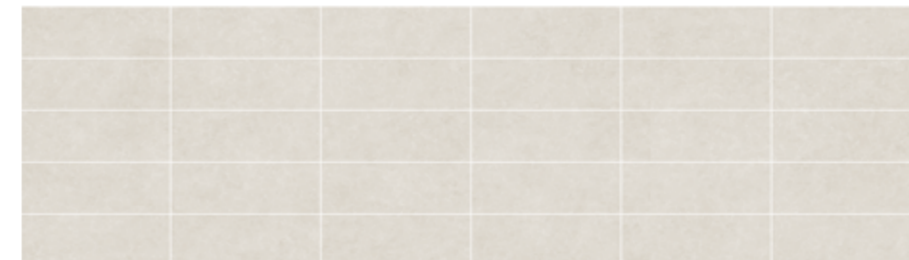

PACKING LIST EMBALAJE

Mosaicos, rodapiés y peldaños disponibles bajo solicitud, ver pag. 211.
Mosaics, skirting boards and steps available on request, see page 211.

SIZE FORMATO	PIECES BOX PIEZAS CAJA	M ² BOX M ² CAJA	KG BOX KG CAJA	BOXES CAJAS	M ² PALLET M ² PALLET	KG PALLET KG PALLET
RECT. 60x60	4	1,44	27	32	46,08	950
RECT. 30x90	5	1,35	22	63	85,05	1.294
RECT. DECOR 30x90	4	1,08	22	63	68,04	1.219

Purestone

PORCELAIN PORCELÁNICO

STONES PIEDRAS

general book 2024

villa
cerámica

SERIE SOLAR

TECHNICAL FEATURES CARACTERÍSTICAS TÉCNICAS

V3 M C1 R9

Purestone



AVAILABLE SIZES FORMATOS DISPONIBLES

30×60
12"×24"

● FACES

30×60 ● 10

PACKING LIST EMBALAJE

Mosaicos, rodapiés y peldaños disponibles bajo solicitud, ver pag. 211.
Mosaics, skirting boards and steps available on request, see page 211.

SIZE FORMATO	PIECES BOX PIEZAS CAJA	M² BOX M² CAJA	KG BOX KG CAJA	BOXES CAJAS	M² PALLET M² PALLET	KG PALLET KG PALLET
30×60	8	1,44	25,2	60	86,4	1.532



PURESTONE 30×60 CM.

Sismic

STONES PIEDRAS

general book 2024

villa
cerámica

COLOURED BODY PORCELAIN PORCELÁNICO MASA COLOREADA

TECHNICAL FEATURES CARACTERÍSTICAS TÉCNICAS

V2 M C1 R9

Sismic White



DIFFERENT GRAPHICS GRÁFICAS DIFERENTES

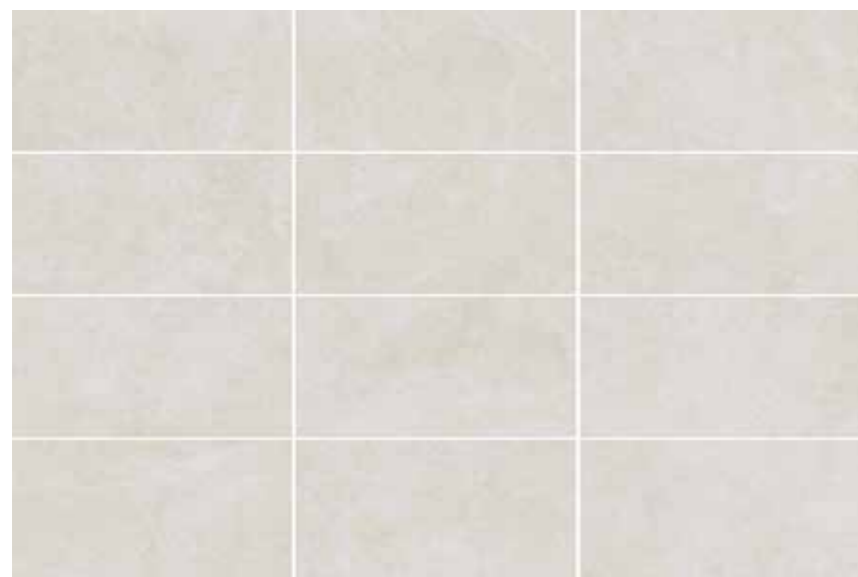

AVAILABLE SIZES FORMATOS DISPONIBLES

RECT. 60x120 RECT. 24"x48"	RECT. 90x90 RECT. 36"x36"	RECT. 30x60 RECT. 12"x36"
	RECT. 60x60 RECT. 24"x24"	

	●	●	●	●	●	FACES
RECT. 60x120	●	●	●	●	●	12
RECT. 90x90	●	●	●	●	●	12
RECT. 60x60	●	●	●	●	●	24
RECT. 30x60				●	●	42



SISMIC CLOUD 90x90 CM.

Sismic

STONES PIEDRAS

general book 2024

villa
cerámica

COLOURED BODY PORCELAIN PORCELÁNICO MASA COLOREADA

TECHNICAL FEATURES CARACTERÍSTICAS TÉCNICAS

V2 M C1 R9

Sismic Cloud



Sismic Earth



Sismic Grey



Sismic Cream



AVAILABLE SIZES FORMATOS DISPONIBLES

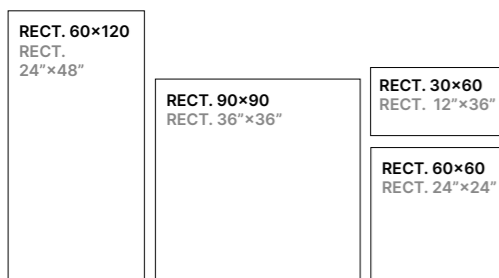

						FACES
RECT. 60x120	●	●	●	●	●	12
RECT. 90x90	●	●	●	●	●	12
RECT. 60x60	●	●	●	●	●	24
RECT. 30x60				●	●	42

Mosaicos, rodapiés y peldaños disponibles bajo solicitud, ver pag. 211.
Mosaics, skirting boards and steps available on request, see page 211.

PACKING LIST EMBALAJE

SIZE FORMATO	PIECES BOX PIEZAS CAJA	M ² BOX M ² CAJA	KG BOX KG CAJA	BOXES CAJAS	M ² PALLET M ² PALLET	KG PALLET KG PALLET
RECT. 60x120	2	1,44	28	36	51,84	1.092
RECT. 90x90	2	1,62	32,5	30	48,6	1.035
RECT. 60x60	4	1,44	27	32	46,08	950
RECT. 30x60	8	1,44	27	40	57,6	1.140

marbles

timeless elegance

An explosion of colours and shapes that give light to materials that seem to be in continuous movement. Its delicate surface is balanced by its impontaneous presence and sophistication. An allegory of sumptuousness that captivates through its light and shimmering surface. Discover a selection of the most sublime marbles.

Una explosión de colores y formas que dan luz a materiales que parecen estar en continuo movimiento. Su delicada superficie se equilibra con su impotente presencia y sofisticación. Una alegoría a la suntuosidad que cautiva a través de su luz y resplandeciente superficie. Descubre una selección de los mármoles más sublimes.

Andromeda

PORCELAIN PORCELÁNICO

MARBLES MÁRMOLES

general book 2024

villa
cerámica

TECHNICAL FEATURES CARACTERÍSTICAS TÉCNICAS

V1 M C1 R9



ANDROMEDA BONE 120×120 CM.

Andromeda

MARBLES MÁRMOLES

general book 2024

villa
cerámica

PORCELAIN PORCELÁNICO

Andromeda Bone



Andromeda Cream



TECHNICAL FEATURES CARACTERÍSTICAS TÉCNICAS

V1 M C1 R9

Andromeda Pearl



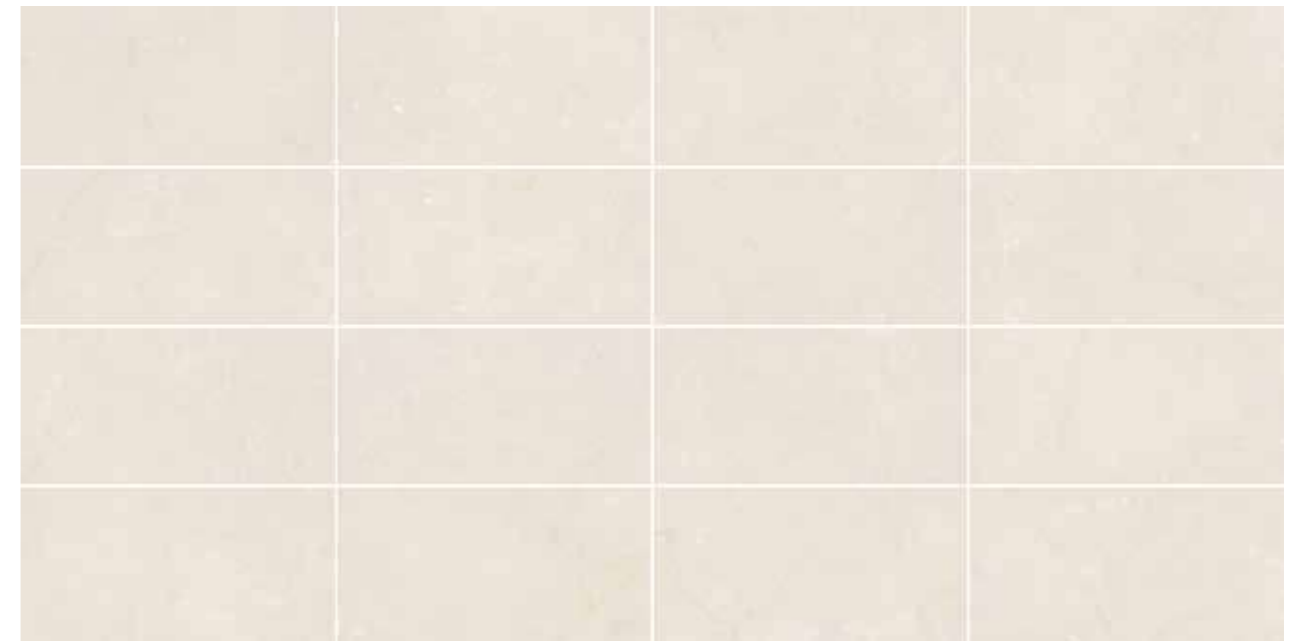

DIFFERENT GRAPHICS GRÁFICAS DIFERENTES



AVAILABLE SIZES FORMATOS DISPONIBLES

RECT. 120x120 RECT. 48"x48"	RECT. 60x120 RECT. 24"x48"	RECT. 60x60 RECT. 24"x24"
--------------------------------	-------------------------------	------------------------------

				FACES
RECT. 120x120	●	●	●	7
RECT. 60x120	●	●	●	16
RECT. 60x60	●	●	●	32

Mosaicos, rodapiés y peldaños disponibles bajo solicitud, ver pag. 211.
Mosaics, skirting boards and steps available on request, see page 211.

PACKING LIST EMBALAJE

SIZE FORMATO	PIECES BOX PIEZAS CAJA	M² BOX M² CAJA	KG BOX KG CAJA	BOXES CAJAS	M² PALLET M² PALLET	KG PALLET KG PALLET
RECT. 120x120	1	1,44	30,13	40	57,6	1.265
RECT. 60x120	2	1,44	28	36	51,84	1.062
RECT. 60x60	4	1,44	27	32	46,8	950

Atmosphere

PORCELAIN PORCELÁNICO

MARBLES MÁRMOLES

general book 2024

villa
cerámica

TECHNICAL FEATURES CARACTERÍSTICAS TÉCNICAS

V3 L



ATMOSPHERE WHITE 90×90 CM.

Atmosphere

MARBLES MÁRMOLES

general book 2024

villa
cerámica

PORCELAIN PORCELÁNICO

TECHNICAL FEATURES CARACTERÍSTICAS TÉCNICAS

V3 L

Atmosphere White



Atmosphere Black



Atmosphere Grey



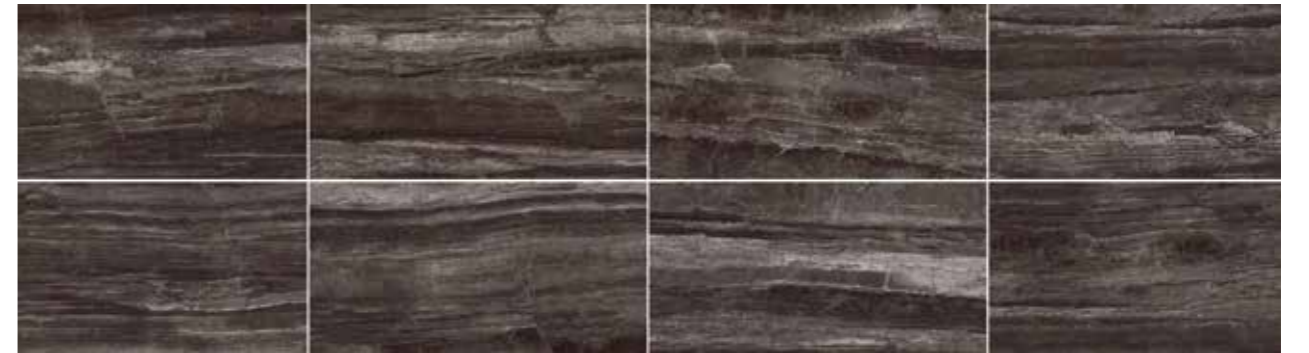

DIFFERENT GRAPHICS GRÁFICAS DIFERENTES

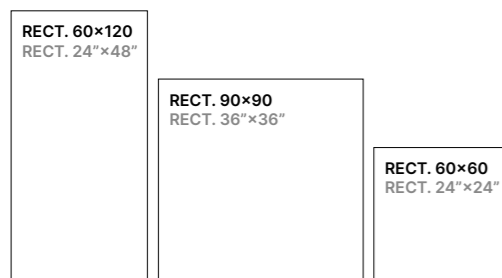

AVAILABLE SIZES FORMATOS DISPONIBLES



				FACES
RECT. 60x120	●	●	●	8
RECT. 90x90	●	●	●	8
RECT. 60x60	●	●	●	8

PACKING LIST EMBALAJE

Mosaicos, rodapiés y peldaños disponibles bajo solicitud, ver pag. 211.
Mosaics, skirting boards and steps available on request, see page 211.

SIZE FORMATO	PIECES BOX PIEZAS CAJA	M ² BOX M ² CAJA	KG BOX KG CAJA	BOXES CAJAS	M ² PALLET M ² PALLET	KG PALLET KG PALLET
RECT. 60x120	2	1,44	34,56	30	38,88	1.037
RECT. 90x90	2	1,62	37,6	27	43,74	1.016
RECT. 60x60	3	1,08	21,9	40	43,2	876

Dust

PORCELAIN PORCELÁNICO

MARBLES MÁRMOLES

general book 2024

villa
cerámica

TECHNICAL FEATURES CARACTERÍSTICAS TÉCNICAS

V1 P

Dust



DIFFERENT GRAPHICS GRÁFICAS DIFERENTES



AVAILABLE SIZES FORMATOS DISPONIBLES

RECT. 60x120
RECT. 24"x48"

FACES

RECT. 60x120 12

PACKING LIST EMBALAJE

Mosaicos, rodapiés y peldaños disponibles bajo solicitud, ver pag. 211.
Mosaics, skirting boards and steps available on request, see page 211.

SIZE FORMATO	PIECES BOX PIEZAS CAJA	M² BOX M² CAJA	KG BOX KG CAJA	BOXES CAJAS	M² PALLET M² PALLET	KG PALLET KG PALLET
RECT. 60x120	2	1,44	30,34	32	46,08	991

120



DUSH POLISHED 60x120 CM.

121

Jump

PORCELAIN PORCELÁNICO

MARBLES MÁRMOLES

general book 2024

villa
cerámica

TECHNICAL FEATURES CARACTERÍSTICAS TÉCNICAS

V3 P 120×120 MP 60×120 MP 60×60



JUMP GOLD POLISHED 60×120 CM.

Jump

PORCELAIN PORCELÁNICO

MARBLES MÁRMOLES

general book 2024

villa
cerámica

TECHNICAL FEATURES CARACTERÍSTICAS TÉCNICAS

V3 P 120×120 MP 60×120 MP 60×60

Jump Silver



Jump Blue



Jump Gold



DIFFERENT GRAPHICS GRÁFICAS DIFERENTES

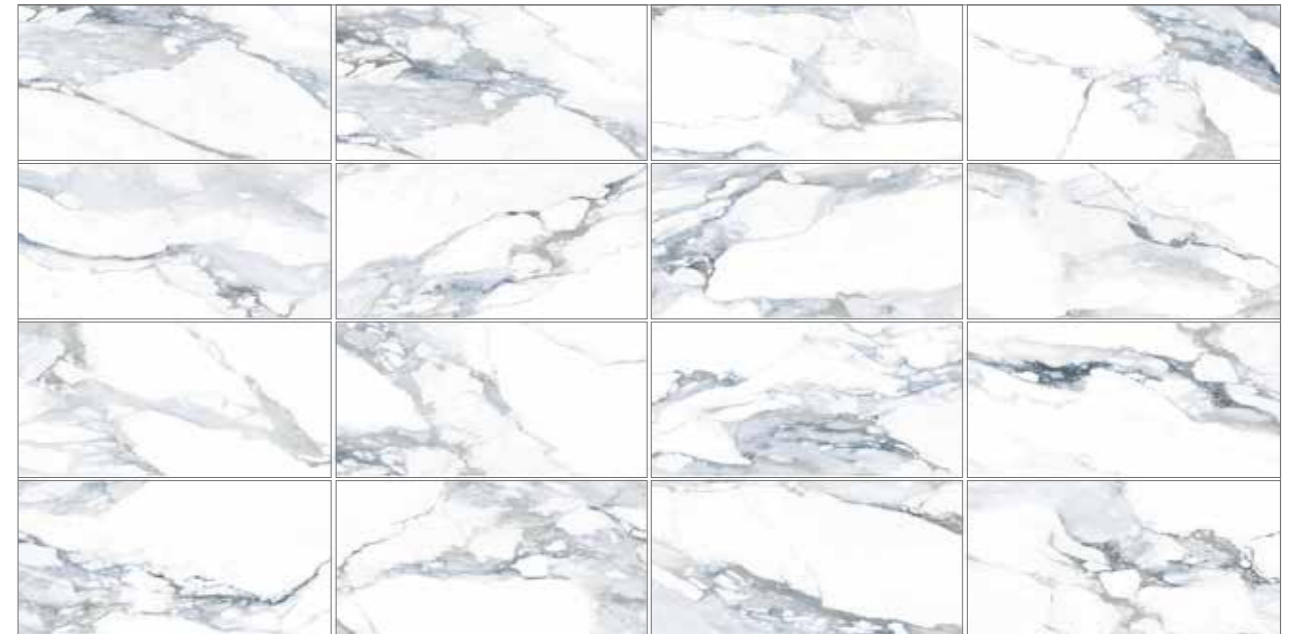

AVAILABLE SIZES FORMATOS DISPONIBLES

RECT. 120×120 RECT. 48"×48"	RECT. 60×120 RECT. 24"×48"	RECT. 60×60 RECT. 24"×24"
--------------------------------	-------------------------------	------------------------------

				FACES
RECT. 120×120	●	●	●	8
RECT. 60×120	●	●	●	16
RECT. 60×60	●	●	●	25

PACKING LIST EMBALAJE

Mosaicos, rodapiés y peldaños disponibles bajo solicitud, ver pag. 211.
Mosaics, skirting boards and steps available on request, see page 211.

SIZE FORMATO	PIECES BOX PIEZAS CAJA	M² BOX M² CAJA	KG BOX KG CAJA	BOXES CAJAS	M² PALLET M² PALLET	KG PALLET KG PALLET
RECT. 120×120	1	1,44	36,36	36	51,84	1.349
RECT. 60×120	2	1,44	23,6	48	51,84	1.091
RECT. 60×60	3	1,08	32,9	30	32,4	1.007

Marma

PORCELAIN PORCELÁNICO

MARBLES MÁRMOLES

general book 2024

villa
cerámica

TECHNICAL FEATURES CARACTERÍSTICAS TÉCNICAS

V1 C1 R9 **MP** 120×120 **MPG** 60×120 **MG** 60×60 **M** 30×60

Marma White



DIFFERENT GRAPHICS GRÁFICAS DIFERENTES

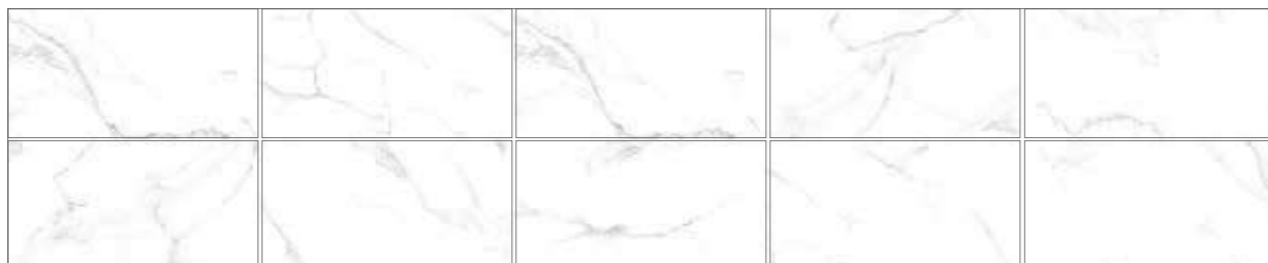

AVAILABLE SIZES FORMATOS DISPONIBLES

RECT. 120×120 RECT. 48"×48"	RECT. 60×120 RECT. 24"×48"	RECT. 30×60 RECT. 12"×24"
		RECT. 60×60 RECT. 24"×24"



FACES

RECT. 120×120	●	5
RECT. 60×120	●	10
RECT. 60×60	●	17
RECT. 30×60	●	34

Mosaicos, rodapiés y peldaños disponibles bajo solicitud, ver pag. 211.
Mosaics, skirting boards and steps available on request, see page 211.

PACKING LIST EMBALAJE

SIZE FORMATO	PIECES BOX PIEZAS CAJA	M ² BOX M ² CAJA	KG BOX KG CAJA	BOXES CAJAS	M ² PALLET M ² PALLET	KG PALLET KG PALLET
RECT. 120×120	1	1,44	36,36	36	51,84	1.349
RECT. 60×120	2	1,44	29,52	36	51,84	1.062
RECT. 60×60	4	1,44	30	30	43,2	920
RECT. 30×60	6	1,08	24	48	51,84	1.152



MARMA WHITE MATT 60×120 CM. MARMA WHITE MATT 30×60 CM.

Meteor

PORCELAIN PORCELÁNICO

MARBLES MÁRMOLES

general book 2024

villa
cerámica

TECHNICAL FEATURES CARACTERÍSTICAS TÉCNICAS

V1 P

Meteor Gold



Meteor Silver



AVAILABLE SIZES FORMATOS DISPONIBLES

RECT. 60x120
RECT. 24"x48"



RECT. 60x120 ● ● 12

PACKING LIST EMBALAJE

Mosaicos, rodapiés y peldaños disponibles bajo solicitud, ver pag. 211.
Mosaics, skirting boards and steps available on request, see page 211.

SIZE FORMATO	PIECES BOX PIEZAS CAJA	M² BOX M² CAJA	KG BOX KG CAJA	BOXES CAJAS	M² PALLET M² PALLET	KG PALLET KG PALLET
RECT. 60x120	2	1,44	30,34	32	46,08	991



METEOR SILVER POLISHED 60x120 CM.

Milky Way

PORCELAIN PORCELÁNICO
WALL TILE REVESTIMIENTO

MARBLES MÁRMOLES

general book 2024

villa
cerámica

TECHNICAL FEATURES CARACTERÍSTICAS TÉCNICAS

PORCELAIN V1 MH WALL TILE V1 M

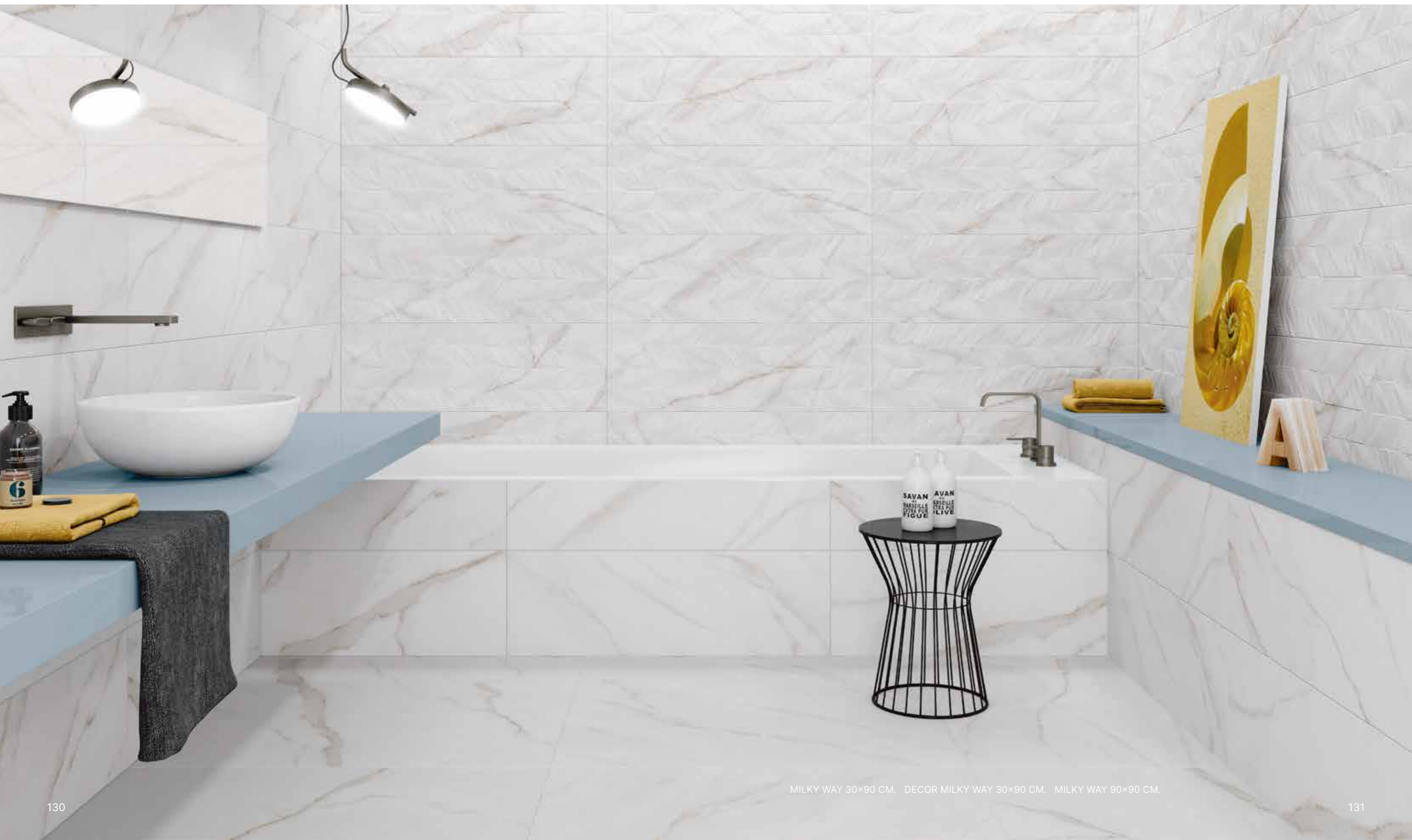

MILKY WAY 30×90 CM. DECOR MILKY WAY 30×90 CM. MILKY WAY 90×90 CM.

Milky Way

MARBLES MÁRMOLES

PORCELAIN PORCELÁNICO
WALL TILE REVESTIMIENTO

Milky Way



DIFFERENT GRAPHICS GRÁFICAS DIFERENTES



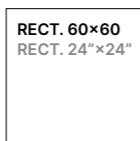
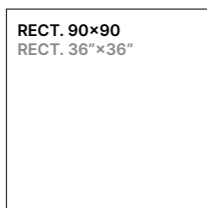

AVAILABLE SIZES FORMATOS DISPONIBLES

PORCELAIN

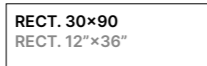

WALL TILE



			FACES
RECT. 60×120	●		10
RECT. 90×90	●		10
RECT. 60×60	●		14
RECT. 30×90		●	11
RECT. DECOR 30×90		●	11

general book 2024

villa
cerámica

TECHNICAL FEATURES CARACTERÍSTICAS TÉCNICAS

PORCELAIN **V1** **MH** WALL TILE **V1** **M**

Decor Milky Way



DIFFERENT GRAPHICS GRÁFICAS DIFERENTES



Mosaicos, rodapiés y peldaños disponibles bajo solicitud, ver pag. 211.
Mosaics, skirting boards and steps available on request, see page 211.

PACKING LIST EMBALAJE

SIZE FORMATO	PIECES BOX PIEZAS CAJA	M ² BOX M ² CAJA	KG BOX KG CAJA	BOXES CAJAS	M ² PALLET M ² PALLET	KG PALLET KG PALLET
RECT. 60×120	2	1,44	34,56	30	38,88	1.037
RECT. 90×90	2	1,62	37,6	27	43,74	1.016
RECT. 60×60	3	1,08	21,9	40	43,2	876
RECT. 30×90	4	1,08	17,88	51	55,08	916
RECT. DECOR 30×90	4	1,08	17,88	51	55,08	916

Orion

MARBLES MÁRMOLES

general book 2024

villa
cerámica

COLOURED BODY PORCELAIN PORCELÁNICO MASA COLOREADA
WALL TILE REVESTIMIENTO

TECHNICAL FEATURES CARACTERÍSTICAS TÉCNICAS

PORCELAIN **V1** **LH** **C1** **R9** WALL TILE **V1** **M**

Orion Pearl





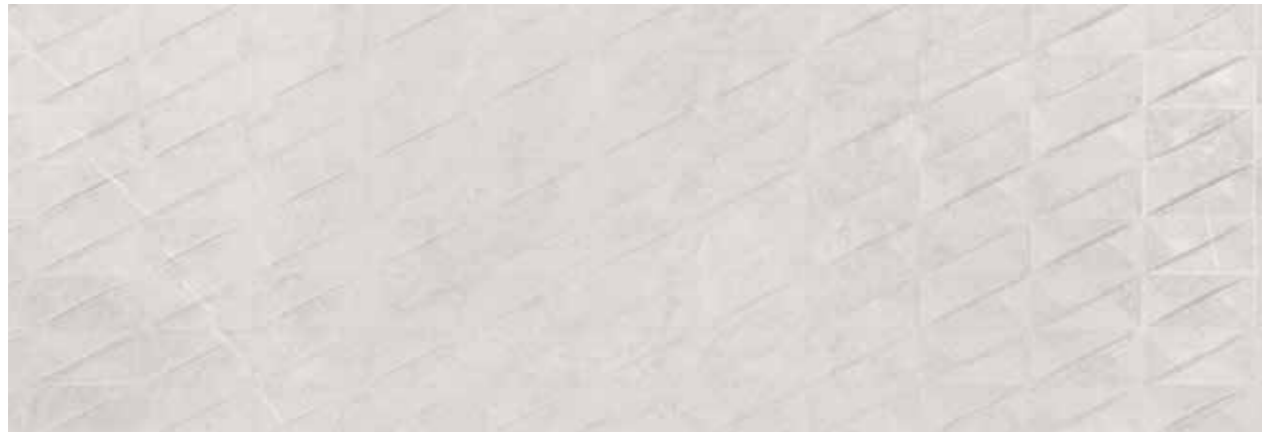

Decor Orion Pearl



AVAILABLE SIZES FORMATOS DISPONIBLES

PORCELAIN

RECT. 60×120 RECT. 24"×48"	RECT. 90×90 RECT. 36"×36"	RECT. 60×60 RECT. 24"×24"
WALL TILE		
RECT. 30×90 RECT. 12"×36"		

						FACES
RECT. 60×120	●	●	●			18
RECT. 90×90	●	●	●			18
RECT. 60×60	●	●	●			18
RECT. 30×90	●	●	●			10
RECT. DEC. 30×90				●	●	5



ORION GREY 60×120 CM. ORION PEARL 30×90 CM. DECOR ORION PEARL 30×90 CM.

Orion

MARBLES MÁRMOLES

general book 2024

villa
cerámica

COLOURED BODY PORCELAIN PORCELÁNICO MASA COLOREADA
WALL TILE REVESTIMIENTO

TECHNICAL FEATURES CARACTERÍSTICAS TÉCNICAS

PORCELAIN **V1** **LH** **C1** **R9** WALL TILE **V1** **M**

Orion Cream



Orion Grey



Decor Orion Cream



DIFFERENT GRAPHICS GRÁFICAS DIFERENTES



AVAILABLE SIZES FORMATOS DISPONIBLES

PORCELAIN

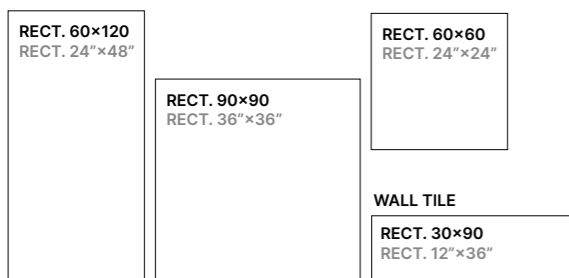

						FACES
RECT. 60×120	●	●	●			18
RECT. 90×90	●	●	●			18
RECT. 60×60	●	●	●			18
RECT. 30×90	●	●	●			10
RECT. DEC. 30×90				●	●	5

PACKING LIST EMBALAJE

Mosaicos, rodapiés y peldaños disponibles bajo solicitud, ver pag. 211.
Mosaics, skirting boards and steps available on request, see page 211.

SIZE FORMATO	PIECES BOX PIEZAS CAJA	M ² BOX M ² CAJA	KG BOX KG CAJA	BOXES CAJAS	M ² PALLET M ² PALLET	KG PALLET KG PALLET
RECT. 60×120	2	1,44	34,56	30	38,88	1.037
RECT. 90×90	2	1,62	37,6	27	43,74	1.016
RECT. 60×60	3	1,08	21,9	40	43,2	876
RECT. 30×90	4	1,08	17,96	51	55,08	935
RECT. DECOR 30×90	4	1,08	17,96	51	55,08	935

Pluto

PORCELAIN PORCELÁNICO

MARBLES MÁRMOLES

general book 2024

villa
cerámica

TECHNICAL FEATURES CARACTERÍSTICAS TÉCNICAS

V1 P

Pluto



DIFFERENT GRAPHICS GRÁFICAS DIFERENTES



AVAILABLE SIZES FORMATOS DISPONIBLES

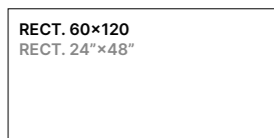

○ FACES

● RECT. 60x120 12

Mosaicos, rodapiés y peldaños disponibles bajo solicitud, ver pag. 211.
Mosaics, skirting boards and steps available on request, see page 211.

PACKING LIST EMBALAJE

SIZE FORMATO	PIECES BOX PIEZAS CAJA	M² BOX M² CAJA	KG BOX KG CAJA	BOXES CAJAS	M² PALLET M² PALLET	KG PALLET KG PALLET
RECT. 60x120	2	1,44	30,34	32	46,08	991



PLUTO 60x120 CM.

Rocket

PORCELAIN RECT. PORCELÁNICO RECT.

MARBLES MÁRMOLES

general book 2024

villa
cerámica

TECHNICAL FEATURES CARACTERÍSTICAS TÉCNICAS

V2 C1 R9 **M**



Rocket

PORCELAIN RECT. PORCELÁNICO RECT.

MARBLES MÁRMOLES

general book 2024

villa
cerámica

TECHNICAL FEATURES CARACTERÍSTICAS TÉCNICAS

V2 C1 R9 **ML**

Rocket Vein Cut Cream



Rocket Vein Cut White



DIFFERENT GRAPHICS GRÁFICAS DIFERENTES

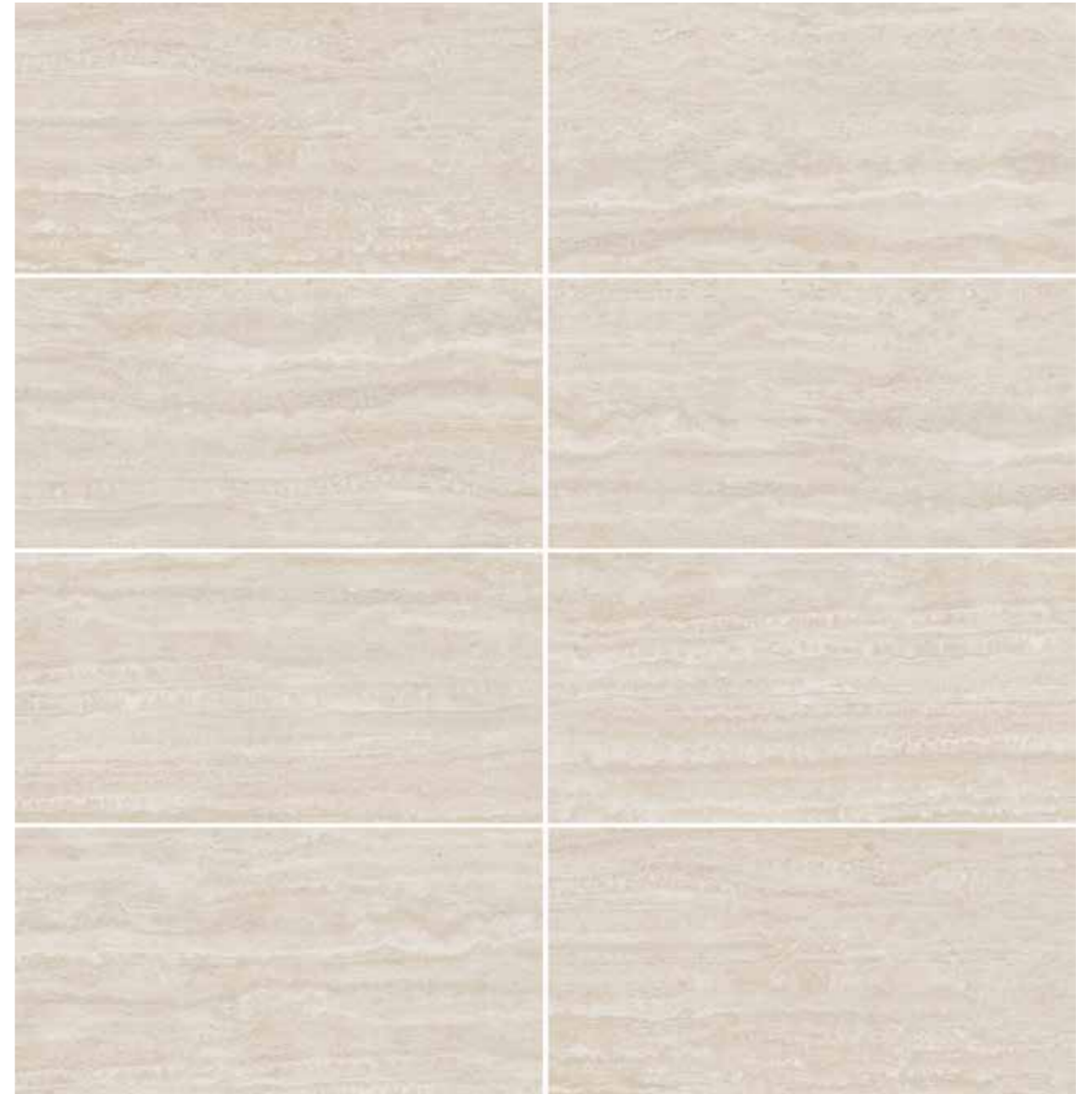

AVAILABLE SIZES FORMATOS DISPONIBLES

RECT. 60x120
RECT. 24"x48"



FACES

RECT. 60x120	●	●	8
--------------	---	---	---

PACKING LIST EMBALAJE

Mosaicos, rodapiés y peldaños disponibles bajo solicitud, ver pag. 211.
Mosaics, skirting boards and steps available on request, see page 211.

SIZE FORMATO	PIECES BOX PIEZAS CAJA	M² BOX M² CAJA	KG BOX KG CAJA	BOXES CAJAS	M² PALLET M² PALLET	KG PALLET KG PALLET
RECT. 60x120	2	1,44	33,3	32	46,08	991

Rocket

PORCELAIN RECT. PORCELÁNICO RECT.

MARBLES MÁRMOLES

general book 2024

villa
cerámica

Rocket Cross Cut Cream



Rocket Cross Cut White



TECHNICAL FEATURES CARACTERÍSTICAS TÉCNICAS

V2 C1 R9 **M L**

DIFFERENT GRAPHICS GRÁFICAS DIFERENTES

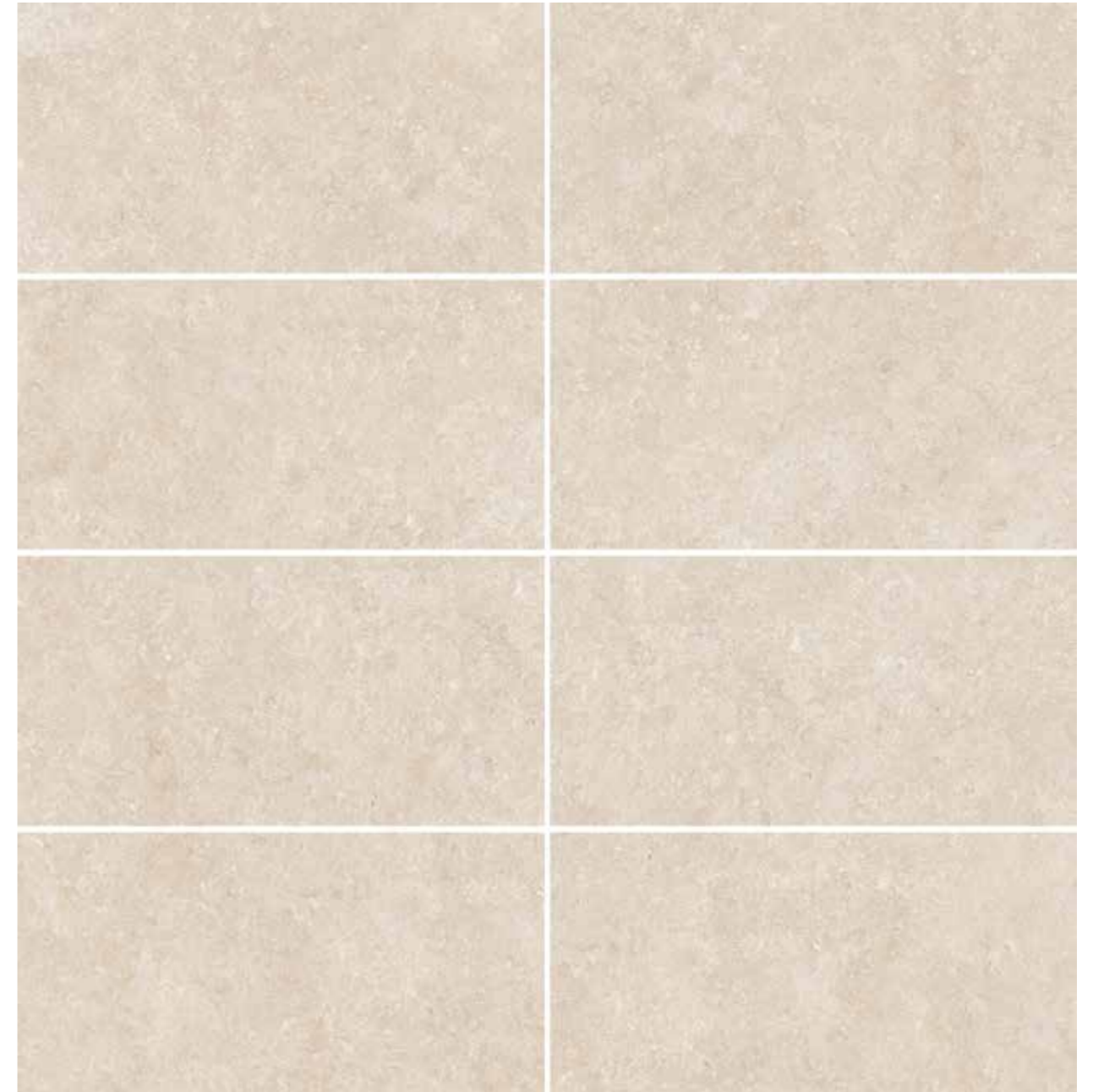

AVAILABLE SIZES FORMATOS DISPONIBLES

RECT. 60×120 RECT. 24"×48"	RECT. 60×60 RECT. 24"×24"
-------------------------------	---------------------------------

				FACES
RECT. 60×120	M L	●	●	8
RECT. 60×60	M	●	●	16

PACKING LIST EMBALAJE

Mosaicos, rodapiés y peldaños disponibles bajo solicitud, ver pag. 211.
Mosaics, skirting boards and steps available on request, see page 211.

SIZE FORMATO	PIECES BOX PIEZAS CAJA	M ² BOX M ² CAJA	KG BOX KG CAJA	BOXES CAJAS	M ² PALLET M ² PALLET	KG PALLET KG PALLET
RECT. 60×120	2	1,44	33,3	32	46,08	991
RECT. 60×60	4	1,44	28,1	30	43,2	862

Satelite

PORCELAIN PORCELÁNICO

MARBLES MÁRMOLES

general book 2024

villa
cerámica

SERIE SOLAR

TECHNICAL FEATURES CARACTERÍSTICAS TÉCNICAS

V1 **GM** C1 R9

Satelite



DIFFERENT GRAPHICS GRÁFICAS DIFERENTES



AVAILABLE SIZES FORMATOS DISPONIBLES

RECT. 60x120 RECT. 24"x48"	30x60 12"x24"	RECT. 60x60 RECT. 24"x24"	60,5x60,5 24"x24"
-------------------------------	------------------	------------------------------	----------------------



FACES

RECT. 60x120	●	18
RECT. 60x60	●	36
60,5x60,5	●	36
30x60	●	18

Mosaicos, rodapiés y peldaños disponibles bajo solicitud, ver pag. 211.
Mosaics, skirting boards and steps available on request, see page 211.

PACKING LIST EMBALAJE

SIZE FORMATO	PIECES BOX PIEZAS CAJA	M ² BOX M ² CAJA	KG BOX KG CAJA	BOXES CAJAS	M ² PALLET M ² PALLET	KG PALLET KG PALLET
RECT. 60x120	2	1,44	31,5	32	46,08	991
RECT. 60x60	4	1,44	28,5	30	43,2	862
60,5x60,5	4	1,46	25,84	40	58,4	1.054
30x60	8	1,44	25,2	60	86,4	1.532



SATELITE GLOSSY 60x120 CM.

Spiral

PORCELAIN PORCELÁNICO

MARBLES MÁRMOLES

general book 2024

villa
cerámica

TECHNICAL FEATURES CARACTERÍSTICAS TÉCNICAS

V1 P M

Spiral



DIFFERENT GRAPHICS GRÁFICAS DIFERENTES



AVAILABLE SIZES FORMATOS DISPONIBLES

RECT. 120×120 RECT. 48"×48"	RECT. 60×120 RECT. 24"×48"
--------------------------------	-------------------------------



FACES

RECT. 120×120	●	8
RECT. 60×120	●	13

PACKING LIST EMBALAJE

Mosaicos, rodapiés y peldaños disponibles bajo solicitud, ver pag. 211.
Mosaics, skirting boards and steps available on request, see page 211.

SIZE FORMATO	PIECES BOX PIEZAS CAJA	M ² BOX M ² CAJA	KG BOX KG CAJA	BOXES CAJAS	M ² PALLET M ² PALLET	KG PALLET KG PALLET
RECT. 120×120	1	1,44	31,4	36	51,84	1.150
RECT. 60×120	2	1,44	30,34	32	46,08	991



SPIRAL POLISHED 60×120 CM.

Sun

PORCELAIN PORCELÁNICO

MARBLES MÁRMOLES

general book 2024

villa
cerámica

SERIE SOLAR

TECHNICAL FEATURES CARACTERÍSTICAS TÉCNICAS

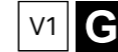

Sun



DIFFERENT GRAPHICS GRÁFICAS DIFERENTES



AVAILABLE SIZES FORMATOS DISPONIBLES

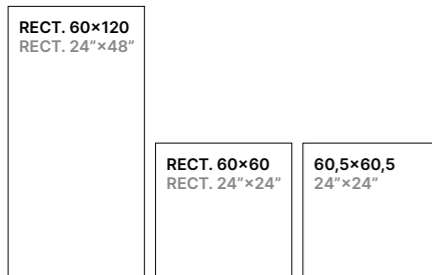

	FACES
RECT. 60x120	3
RECT. 60x60	9
60,5x60,5	9

Mosaicos, rodapiés y peldaños disponibles bajo solicitud, ver pag. 211.
Mosaics, skirting boards and steps available on request, see page 211.

PACKING LIST EMBALAJE

SIZE FORMATO	PIECES BOX PIEZAS CAJA	M ² BOX M ² CAJA	KG BOX KG CAJA	BOXES CAJAS	M ² PALLET M ² PALLET	KG PALLET KG PALLET
RECT. 60x120	2	1,44	34,25	32	46,08	1.121
RECT. 60x60	4	1,44	28,1	30	43,2	862
60,5x60,5	4	1,46	25,84	40	58,4	1.054



SUN 60x60 CM.

Supreme

PORCELAIN PORCELÁNICO

MARBLES MÁRMOLES

general book 2024

villa
cerámica

TECHNICAL FEATURES CARACTERÍSTICAS TÉCNICAS

V1 P 60×120 G 60×60



SUPREME GREY GLOSSY 60×60 CM.

Supreme

PORCELAIN PORCELÁNICO

MARBLES MÁRMOLES

general book 2024

villa
cerámica

Supreme Perla



Supreme Grey



TECHNICAL FEATURES CARACTERÍSTICAS TÉCNICAS

V1 P 60×120 G 60×60

Supreme Cream





DIFFERENT GRAPHICS GRÁFICAS DIFERENTES

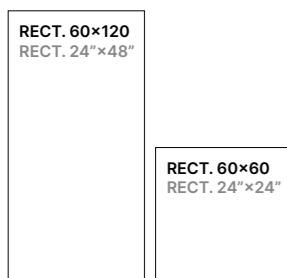

AVAILABLE SIZES FORMATOS DISPONIBLES



				FACES
RECT. 60×120	●	●	●	12
RECT. 60×60	●	●	●	32

Mosaicos, rodapiés y peldaños disponibles bajo solicitud, ver pag. 211.
Mosaics, skirting boards and steps available on request, see page 211.

PACKING LIST EMBALAJE

SIZE FORMATO	PIECES BOX PIEZAS CAJA	M ² BOX M ² CAJA	KG BOX KG CAJA	BOXES CAJAS	M ² PALLET M ² PALLET	KG PALLET KG PALLET
RECT. 60×120	2	1,44	34,5	32	46,08	1.124
RECT. 60×60	4	1,44	30	30	43,2	920

Venus

PORCELAIN PORCELÁNICO

MARBLES MÁRMOLES

general book 2024

villa
cerámica

TECHNICAL FEATURES CARACTERÍSTICAS TÉCNICAS

V1 PMP 120×120



VENUS GREY POLISHED 60×120 CM.

Venus

PORCELAIN PORCELÁNICO

MARBLES MÁRMOLES

general book 2024

villa
cerámica

TECHNICAL FEATURES CARACTERÍSTICAS TÉCNICAS

V1 PMP 120x120

Venus White



Venus Sand



Venus Grey



DIFFERENT GRAPHICS GRÁFICAS DIFERENTES



AVAILABLE SIZES FORMATOS DISPONIBLES

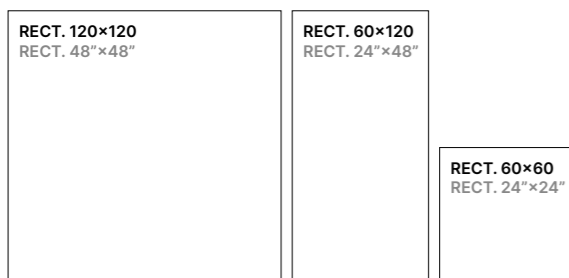

				FACES
RECT. 120x120	●	●	●	6
RECT. 60x120	●	●	●	12
RECT. 60x60	●	●	●	24

PACKING LIST EMBALAJE

Mosaicos, rodapiés y peldaños disponibles bajo solicitud, ver pag. 211.
Mosaics, skirting boards and steps available on request, see page 211.

SIZE FORMATO	PIECES BOX PIEZAS CAJA	M² BOX M² CAJA	KG BOX KG CAJA	BOXES CAJAS	M² PALLET M² PALLET	KG PALLET KG PALLET
RECT. 120x120	1	1,44	31,4	36	51,84	1.150
RECT. 60x120	2	1,44	33,3	32	46,08	991
RECT. 60x60	4	1,44	28,1	30	43,2	862

villa
ceramica

wood

natural warmth

A harmonious fusion between the natural warmth of wood and the durability of ceramic material. These pieces stand out for their astonishing realism, capturing the texture, knots and characteristic shades of the grain. Their versatility allows for the creation of cosy and timeless spaces.

Una fusión armoniosa entre la calidez natural de la madera y la durabilidad del material cerámico. Estas piezas destacan por su realismo asombroso, capturando la textura, los nudos y las tonalidades característicos del veteado. Su versatilidad permite crear espacios acogedores y atemporales.

Cava

PORCELAIN PORCELÁNICO

WOODS MADERAS

general book 2024

villa
cerámica

TECHNICAL FEATURES CARACTERÍSTICAS TÉCNICAS

V2 **M** C2 R10 DCOF>0.42 PTV+36

Cava Grey



Cava Haya



Cava Natural



DIFFERENT GRAPHICS GRÁFICAS DIFERENTES



AVAILABLE SIZES FORMATOS DISPONIBLES

RECT. 20×120
RECT. 8"×48"

RECT. 20×120  FACES 33

PACKING LIST EMBALAJE

SIZE FORMATO	PIECES BOX PIEZAS CAJA	M ² BOX M ² CAJA	KG BOX KG CAJA	BOXES CAJAS	M ² PALLET M ² PALLET	KG PALLET KG PALLET
RECT. 20×120	7	1,68	31,93	44	73,92	1.420

Mosaicos, rodapiés y peldaños disponibles bajo solicitud, ver pag. 211.
Mosaics, skirting boards and steps available on request, see page 211.



CAVA NATURAL 20×120 CM.

Comet

PORCELAIN PORCELÁNICO

WOODS MADERAS

general book 2024

villa
cerámica

TECHNICAL FEATURES CARACTERÍSTICAS TÉCNICAS

V1 **M** C2 R10 DCOF>0.42 PTV+36

Comet Grey



Comet Taupe



Comet Oak



Comet Cherry



DIFFERENT GRAPHICS GRÁFICAS DIFERENTES

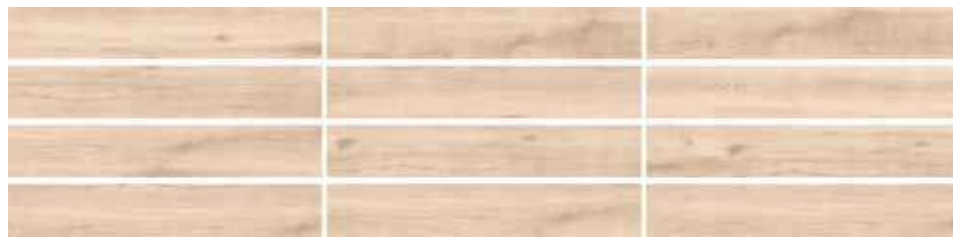

AVAILABLE SIZES FORMATOS DISPONIBLES

RECT. 20x120
RECT. 8"x48"

	●	●	●	●	FACES
RECT. 20x120	●	●	●	●	12

PACKING LIST EMBALAJE

SIZE FORMATO	PIECES BOX PIEZAS CAJA	M ² BOX M ² CAJA	KG BOX KG CAJA	BOXES CAJAS	M ² PALLET M ² PALLET	KG PALLET KG PALLET
RECT. 20x120	5	1,2	25,24	45	54	1.166

Mosaicos, rodapiés y peldaños disponibles bajo solicitud, ver pag. 211.
Mosaics, skirting boards and steps available on request, see page 211.



COMET TAUPE 20x120 CM.

Matter

PORCELAIN PORCELÁNICO

WOODS MADERAS

general book 2024

villa
cerámica

TECHNICAL FEATURES CARACTERÍSTICAS TÉCNICAS

V2 **M** C2 R10 DCOF>0.42 PTV+36

Matter Pearl



Matter Natural



Matter Oak



Matter Nut



DIFFERENT GRAPHICS GRÁFICAS DIFERENTES



AVAILABLE SIZES FORMATOS DISPONIBLES

RECT. 20×120
RECT. 8"×48"

● ● ● ● FACES
RECT. 20×120 30

Mosaicos, rodapiés y peldaños disponibles bajo solicitud, ver pag. 211.
Mosaics, skirting boards and steps available on request, see page 211.

PACKING LIST EMBALAJE

SIZE FORMATO	PIECES BOX PIEZAS CAJA	M² BOX M² CAJA	KG BOX KG CAJA	BOXES CAJAS	M² PALLET M² PALLET	KG PALLET KG PALLET
RECT. 20×120	6	1,44	31,77	36	51,84	1.144



MATTER NATURAL 20×120 CM.

Orbit

PORCELAIN PORCELÁNICO

WOODS MADERAS

general book 2024

villa
cerámica

SERIE SOLAR

TECHNICAL FEATURES CARACTERÍSTICAS TÉCNICAS

V2 **M** C3 R11 DCOF>0.42 PTV+36

Orbit Grey



Orbit Natural



Orbit Oak



Orbit Cherry



DIFFERENT GRAPHICS GRÁFICAS DIFERENTES



AVAILABLE SIZES FORMATOS DISPONIBLES

RECT. 22,5×119,5
RECT. 9"×47"

● ● ● ● FACES
RECT. 22,5×119,5 10

Mosaicos, rodapiés y peldaños disponibles bajo solicitud, ver pag. 211.
Mosaics, skirting boards and steps available on request, see page 211.

PACKING LIST EMBALAJE

SIZE FORMATO	PIECES BOX PIEZAS CAJA	M ² BOX M ² CAJA	KG BOX KG CAJA	BOXES CAJAS	M ² PALLET M ² PALLET	KG PALLET KG PALLET
RECT. 22,5×119,5	6	1,61	30,8	42	67,62	1.315



ORBIT NATURAL 22,5×119,5 CM.

Planet

PORCELAIN PORCELÁNICO

WOODS MADERAS

general book 2024

villa
cerámica

TECHNICAL FEATURES CARACTERÍSTICAS TÉCNICAS

V2 M C2 R10 DCOF>0.42 PTV+36

Planet Grey



Planet Natural

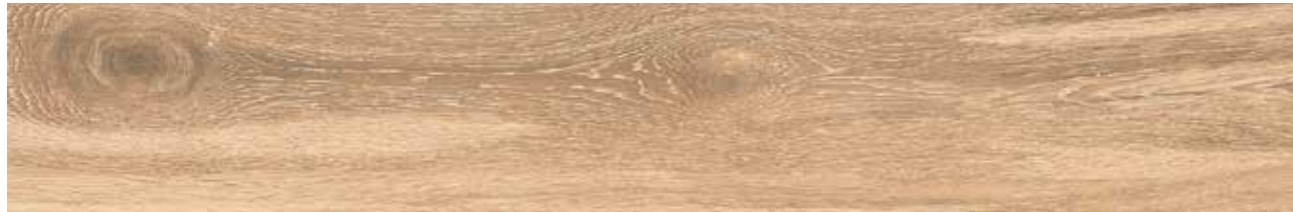

Planet Oak



Planet Walnut



DIFFERENT GRAPHICS GRÁFICAS DIFERENTES



AVAILABLE SIZES FORMATOS DISPONIBLES

RECT. 20x120
RECT. 8"x48"

RECT. 20x120

● ● ● ● FACES 30

Mosaicos, rodapiés y peldaños disponibles bajo solicitud, ver pag. 211.
Mosaics, skirting boards and steps available on request, see page 211.

PACKING LIST EMBALAJE

SIZE FORMATO	PIECES BOX PIEZAS CAJA	M² BOX M² CAJA	KG BOX KG CAJA	BOXES CAJAS	M² PALLET M² PALLET	KG PALLET KG PALLET
RECT. 20x120	6	1,44	31,77	36	51,84	1.144



PLANET OAK 20x120 CM.

Prego

PORCELAIN PORCELÁNICO

WOODS MADERAS

SERIE SOLAR

Prego Beige



Prego Grey



DIFFERENT GRAPHICS GRÁFICAS DIFERENTES



AVAILABLE SIZES FORMATOS DISPONIBLES

23,3×120
9"×48"

23,3×120



PACKING LIST EMBALAJE

Mosaicos, rodapiés y peldaños disponibles bajo solicitud, ver pag. 211.
Mosaics, skirting boards and steps available on request, see page 211.

SIZE FORMATO	PIECES BOX PIEZAS CAJA	M² BOX M² CAJA	KG BOX KG CAJA	BOXES CAJAS	M² PALLET M² PALLET	KG PALLET KG PALLET
23,3×120	6	1,68	30,9	42	70,56	1.318

general book 2024

villa
cerámica

TECHNICAL FEATURES CARACTERÍSTICAS TÉCNICAS

V3 **M** C2 R10 **ANTISLIP** C3 R11 DCOF>0.42 PTV+36



PREGO GREY 23,3×120 CM.

Spark

PORCELAIN PORCELÁNICO

WOODS MADERAS

general book 2024

villa
cerámica

SERIE SOLAR

TECHNICAL FEATURES CARACTERÍSTICAS TÉCNICAS

V2 **M** PTV 25-35 C1 R9

Spark White



Spark Grey



Spark Basein



Spark Oak



DIFFERENT GRAPHICS GRÁFICAS DIFERENTES



AVAILABLE SIZES FORMATOS DISPONIBLES

22,5×90
9"×36"

22,5×90 ● ● ● ● FACES 24

Mosaicos, rodapiés y peldaños disponibles bajo solicitud, ver pag. 211.
Mosaics, skirting boards and steps available on request, see page 211.

PACKING LIST EMBALAJE

SIZE FORMATO	PIECES BOX PIEZAS CAJA	M² BOX M² CAJA	KG BOX KG CAJA	BOXES CAJAS	M² PALLET M² PALLET	KG PALLET KG PALLET
22,5×90	6	1,22	22,5	60	72,9	1.350



SPARK GREY 22,5×90 CM.

Tropic

PORCELAIN PORCELÁNICO

WOODS MADERAS

general book 2024

villa
cerámica

TECHNICAL FEATURES CARACTERÍSTICAS TÉCNICAS

V3 **M** C2 R10 DCOF>0.42 PTV+36

Tropic Winter



Tropic Haya



Tropic Nuez



Tropic Cerezo



DIFFERENT GRAPHICS GRÁFICAS DIFERENTES



AVAILABLE SIZES FORMATOS DISPONIBLES

RECT. 20x120
RECT. 8"x48"

● ● ● ● FACES

RECT. 20x120 ● ● ● ● 15

PACKING LIST EMBALAJE

SIZE FORMATO	PIECES BOX PIEZAS CAJA	M² BOX M² CAJA	KG BOX KG CAJA	BOXES CAJAS	M² PALLET M² PALLET	KG PALLET KG PALLET
RECT. 20x120	5	1,2	23,5	45	54	1.074

Mosaicos, rodapiés y peldaños disponibles bajo solicitud, ver pag. 211.
Mosaics, skirting boards and steps available on request, see page 211.



TROPIC NUEZ 20x120 CM.

Western

PORCELAIN PORCELÁNICO

WOODS MADERAS

general book 2024

villa
cerámica

SERIE SOLAR

TECHNICAL FEATURES CARACTERÍSTICAS TÉCNICAS

V2 **M** C2 R10 DCOF>0.42 PTV+36

Western White



Western Beige



Western Taupe



Western Natural



DIFFERENT GRAPHICS GRÁFICAS DIFERENTES



AVAILABLE SIZES FORMATOS DISPONIBLES

23,3×120
9"×48"

23,3×120 ● ● ● ● 9



FACES

PACKING LIST EMBALAJE

SIZE FORMATO	PIECES BOX PIEZAS CAJA	M² BOX M² CAJA	KG BOX KG CAJA	BOXES CAJAS	M² PALLET M² PALLET	KG PALLET KG PALLET
23,3×120	6	1,68	30,9	42	70,56	1.318

Mosaicos, rodapiés y peldaños disponibles bajo solicitud, ver pag. 211.
Mosaics, skirting boards and steps available on request, see page 211.



WESTERN NATURAL 23,3×120 CM.

Wild

PORCELAIN PORCELÁNICO

Wild Blanco



Wild Gris



Wild Miel



Wild Natural



DIFFERENT GRAPHICS GRÁFICAS DIFERENTES



AVAILABLE SIZES FORMATOS DISPONIBLES

22,5×90
9"×36"

22,5×90	FACES				21
●	●	●	●		

Mosaicos, rodapiés y peldaños disponibles bajo solicitud, ver pag. 211.
Mosaics, skirting boards and steps available on request, see page 211.

PACKING LIST EMBALAJE

SIZE FORMATO	PIECES BOX PIEZAS CAJA	M² BOX M² CAJA	KG BOX KG CAJA	BOXES CAJAS	M² PALLET M² PALLET	KG PALLET KG PALLET
22,5×90	6	1,22	22,5	60	72,9	1.350

WOODS MADERAS

SERIE SOLAR

general book 2024

villa
cerámica

TECHNICAL FEATURES CARACTERÍSTICAS TÉCNICAS

V2 M ANTISLIP C3 R11 DCOF>0.42 PTV+36



WILD MIEL 22,5×90 CM.

villa
ceramica

cotto

the genuine tiles

Cotto is tradition in ceramics, the sophistication of the genuine and ancient. We invite you to discover our collection of cottos in which we combine tradition and new technologies.

El Cotto es la tradición en cerámica, la sofisticación de lo genuino y antiguo. Te invitamos a conocer nuestra colección de cottos en la que aunamos tradición y nuevas tecnologías.

Arcadia

PORCELAIN PORCELÁNICO
WALL TILE REVESTIMIENTO

COTTO COTTO

general book 2024

villa
ceramica

TECHNICAL FEATURES CARACTERÍSTICAS TÉCNICAS

V1 G



ARCADIA WHITE 6,5×26 CM. ARCADIA FOREST 6,5×26 CM.

Arcadia

COTTO COTTO

general book 2024

villa
ceramica

PORCELAIN PORCELÁNICO
WALL TILE REVESTIMIENTO

Arcadia Off-White 30×60



Arcadia White 6,5×26



Arcadia White 13×13

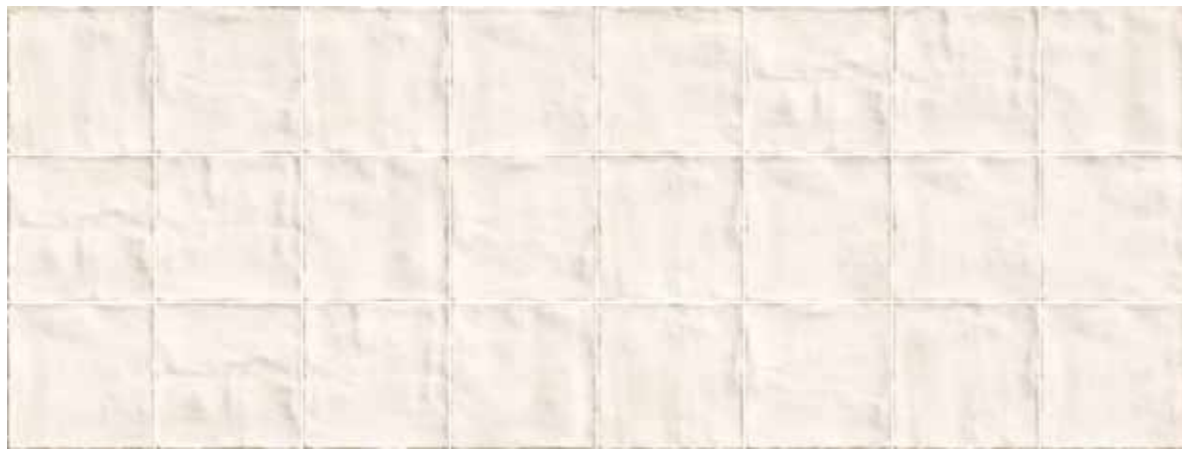

TECHNICAL FEATURES CARACTERÍSTICAS TÉCNICAS

V1 G

Arcadia Cream 30×60



Arcadia Cream 6,5×26

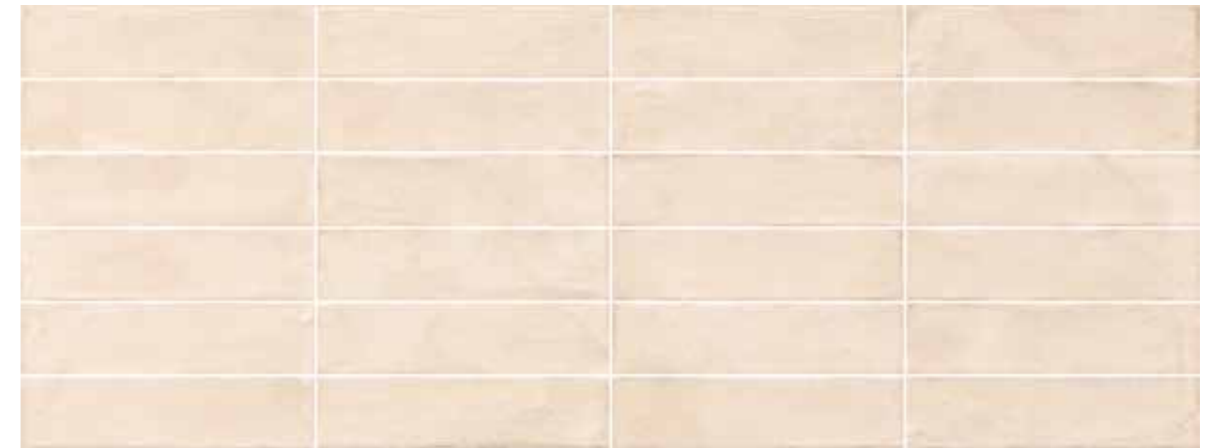





Arcadia Cream 13×13



AVAILABLE SIZES FORMATOS DISPONIBLES

PORCELAIN	WALL TILE
30×60 12"×24"	13×13 5"×5"
	6,5×26 2"×10"

						FACES
30×60	●	●	●	●	●	6
13×13	●	●	●	●	●	20
6,5×26	●	●	●	●	●	24

SIZE FORMATO	PIECES BOX PIEZAS CAJA	M ² BOX M ² CAJA	KG BOX KG CAJA	BOXES CAJAS	M ² PALLET M ² PALLET	KG PALLET KG PALLET
30×60	6	1,08	21,24	72	77,76	1.545
13×13	30	0,50	7,5	120	60,84	910
6,5×26	30	0,50	7	120	60	850

Arcadia

PORCELAIN PORCELÁNICO
WALL TILE REVESTIMIENTO

COTTO COTTO

general book 2024

villa
cerámica

TECHNICAL FEATURES CARACTERÍSTICAS TÉCNICAS

V1 G

Arcadia Sky 30×60



Arcadia Sky 6,5×26

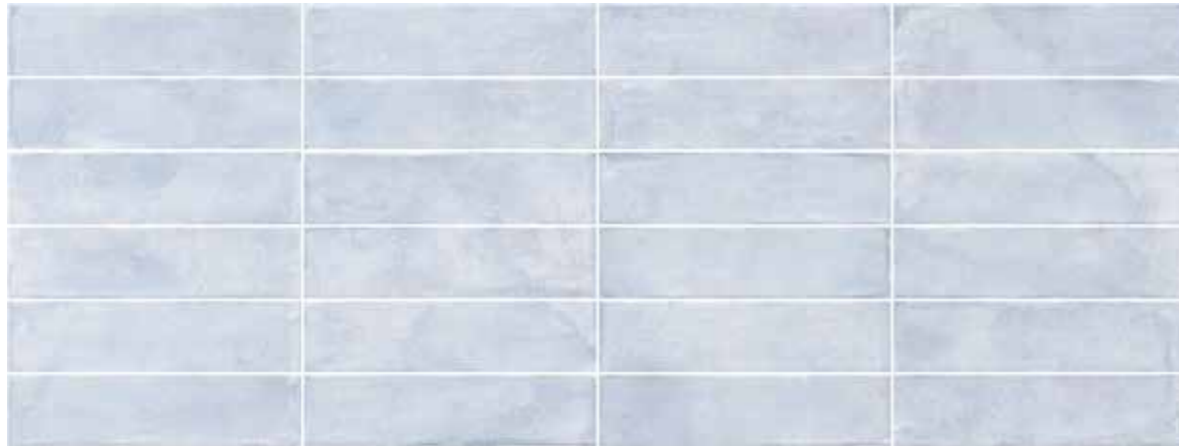

Arcadia Sky 13×13



Arcadia Forest 30×60



Arcadia Forest 6,5×26



Arcadia Forest 13×13



AVAILABLE SIZES FORMATOS DISPONIBLES

PORCELAIN

WALL TILE

30×60
12"×24"

13×13 5"×5"

6,5×26 2"×10"



FACES

SIZE	FACE 1	FACE 2	FACE 3	FACE 4	FACES
30×60	●	●	●	●	6
13×13	●	●	●	●	20
6,5×26	●	●	●	●	24

SIZE FORMATO	PIECES BOX PIEZAS CAJA	M ² BOX M ² CAJA	KG BOX KG CAJA	BOXES CAJAS	M ² PALLET M ² PALLET	KG PALLET KG PALLET
30×60	6	1,08	21,24	72	77,76	1.545
13×13	30	0,50	7,5	120	60,84	910
6,5×26	30	0,50	7	120	60	850

Cotto

PORCELAIN PORCELÁNICO

COTTO COTTO

general book 2024

villa
cerámica

SERIE SOLAR

TECHNICAL FEATURES CARACTERÍSTICAS TÉCNICAS

V1 M C3 R11 DCOF>0.42 PTV+36

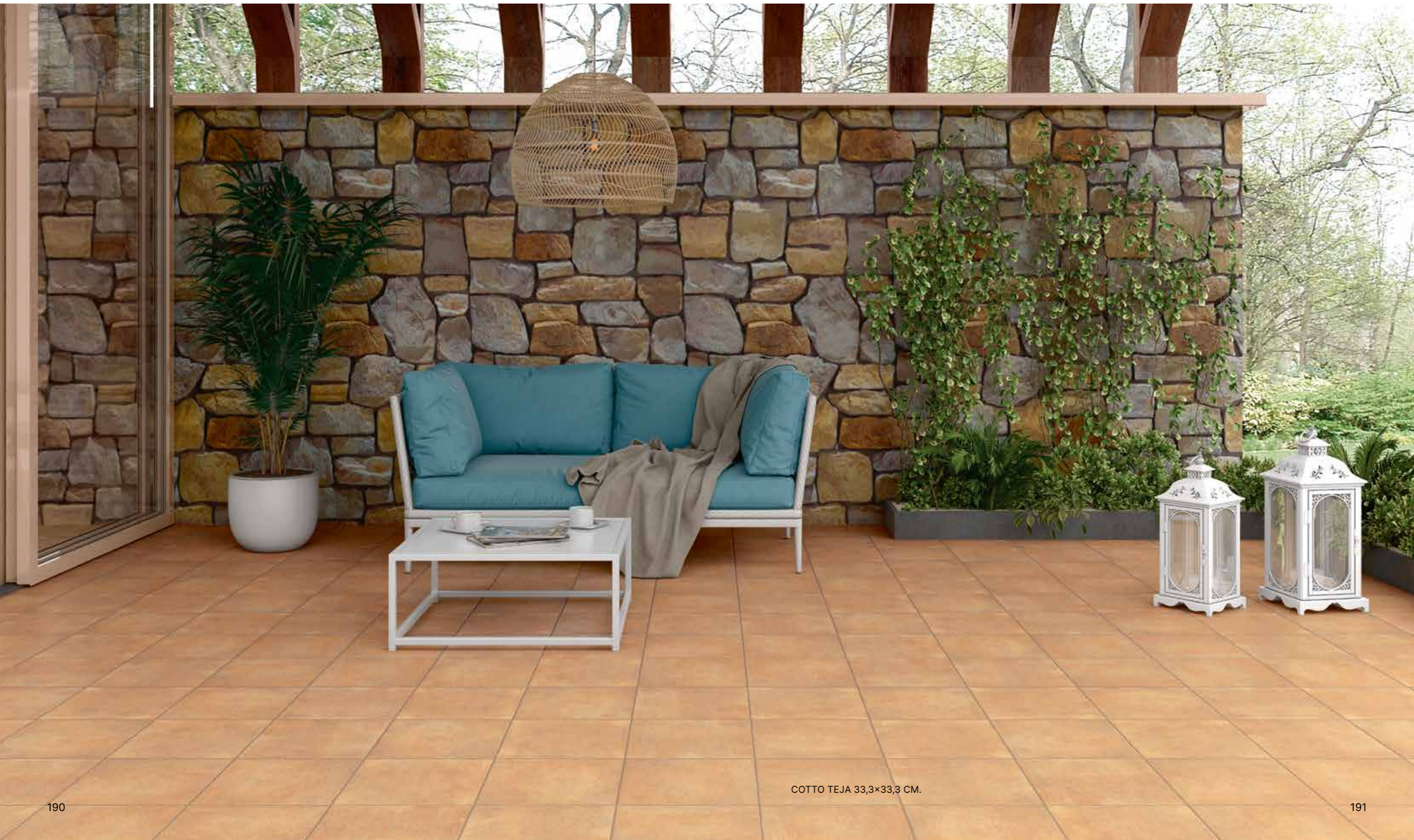

COTTO TEJA 33,3×33,3 CM.

Cotto

PORCELAIN PORCELÁNICO

COTTO COTTO

general book 2024

villa
ceramica

SERIE SOLAR

TECHNICAL FEATURES CARACTERÍSTICAS TÉCNICAS

V1 M C3 R11 DCOF>0.42 PTV+36

Cotto Arena



Cotto Teja



Cotto Trapaga



DIFFERENT GRAPHICS GRÁFICAS DIFERENTES

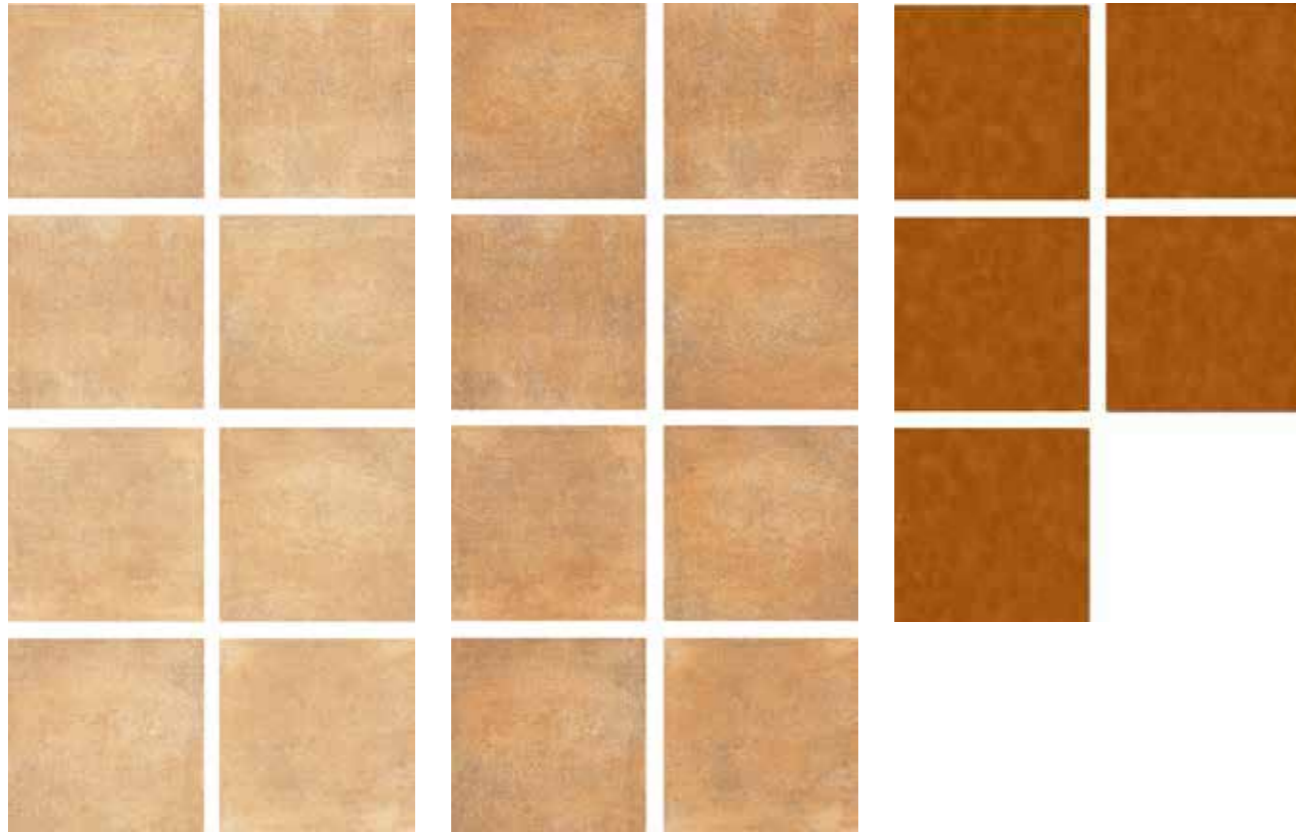

Cotto Derio



Cotto Magma

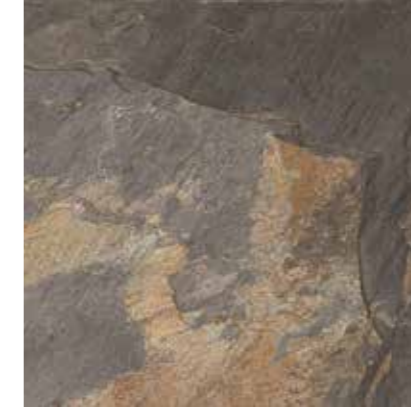

Cotto Pardo



AVAILABLE SIZES FORMATOS DISPONIBLES

33,3x33,3
13"x13"

33,3x33,3	●	●	●	●	●	●
FACES	8	8	5	4	13	8

PACKING LIST EMBALAJE

SIZE FORMATO	PIECES BOX PIEZAS CAJA	M ² BOX M ² CAJA	KG BOX KG CAJA	BOXES CAJAS	M ² PALLET M ² PALLET	KG PALLET KG PALLET
33,3x33,3	14	1,55	24,99	52	80,87	1.323

Mosaicos, rodapiés y peldaños disponibles bajo solicitud, ver pag. 211.
Mosaics, skirting boards and steps available on request, see page 211.

Icarus

WALL TILE REVESTIMIENTO

COTTO COTTO

general book 2024

villa
ceramica

TECHNICAL FEATURES CARACTERÍSTICAS TÉCNICAS

V1 G



Icarus

WALL TILE REVESTIMIENTO

COTTO COTTO

general book 2024

villa
ceramica

TECHNICAL FEATURES CARACTERÍSTICAS TÉCNICAS

V1 G

Icarus White



Decor Icarus White

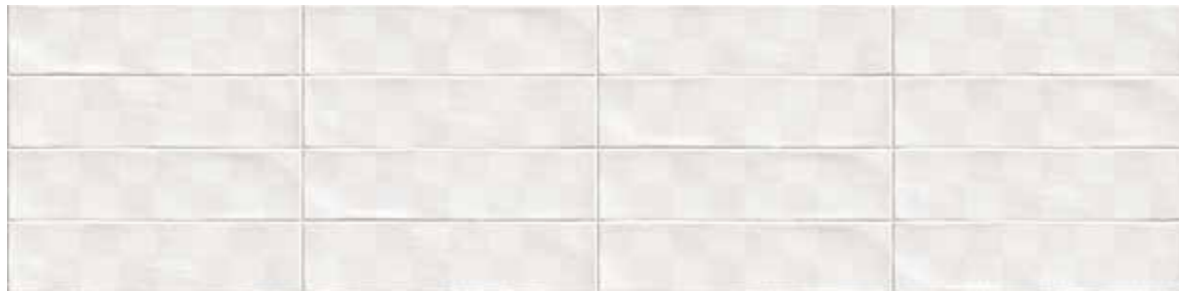

Icarus Cream



Decor Icarus Cream



Icarus Grey



Icarus Blue



Icarus Bottle



AVAILABLE SIZES FORMATOS DISPONIBLES

7,5x30 2" x 12"



PACKING LIST EMBALAJE

SIZE FORMATO	PIECES BOX PIEZAS CAJA	M ² BOX M ² CAJA	KG BOX KG CAJA	BOXES CAJAS	M ² PALLET M ² PALLET	KG PALLET KG PALLET
7,5x30	22	0,495	7,0	120	59,40	860

whites

a calm light

The white collections offer a flawless finish with a timeless and elegant aesthetic that adapts to any style and surface. The combination of its luminosity and simplicity is the key to its versatility, inspiring a serene atmosphere full of possibilities.

Las colecciones de Blancos ofrecen un acabado impoluto con una estética atemporal y elegante, que se adapta a cualquier estilo y superficie. La combinación de su luminosidad con la simplicidad es la clave de su versatilidad, inspirando un ambiente sereno y lleno de posibilidades.

Apolo

WALL TILE REVESTIMIENTO

WHITES BLANCOS

general book 2024

villa
ceramica

TECHNICAL FEATURES CARACTERÍSTICAS TÉCNICAS

V1 GM

Apolo

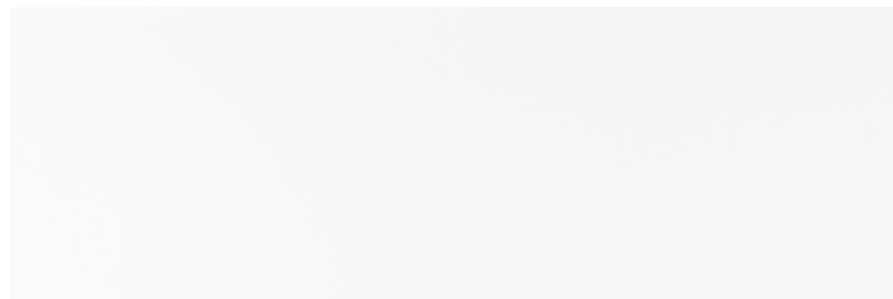

Decor Apolo Brillo



AVAILABLE SIZES FORMATOS DISPONIBLES

RECT. 30×90
RECT. 12"×36"

RECT. 30×90

RECT. DECOR 30×90

PACKING LIST EMBALAJE

SIZE FORMATO	PIECES BOX PIEZAS CAJA	M ² BOX M ² CAJA	KG BOX KG CAJA	BOXES CAJAS	M ² PALLET M ² PALLET	KG PALLET KG PALLET
RECT. 30×90	5	1,35	22	63	85,05	1.294
RECT. DECOR 30×90	4	1,08	22	63	68,04	1.219

Mosaicos, rodapiés y peldaños disponibles bajo solicitud, ver pag. 211.
Mosaics, skirting boards and steps available on request, see page 211.

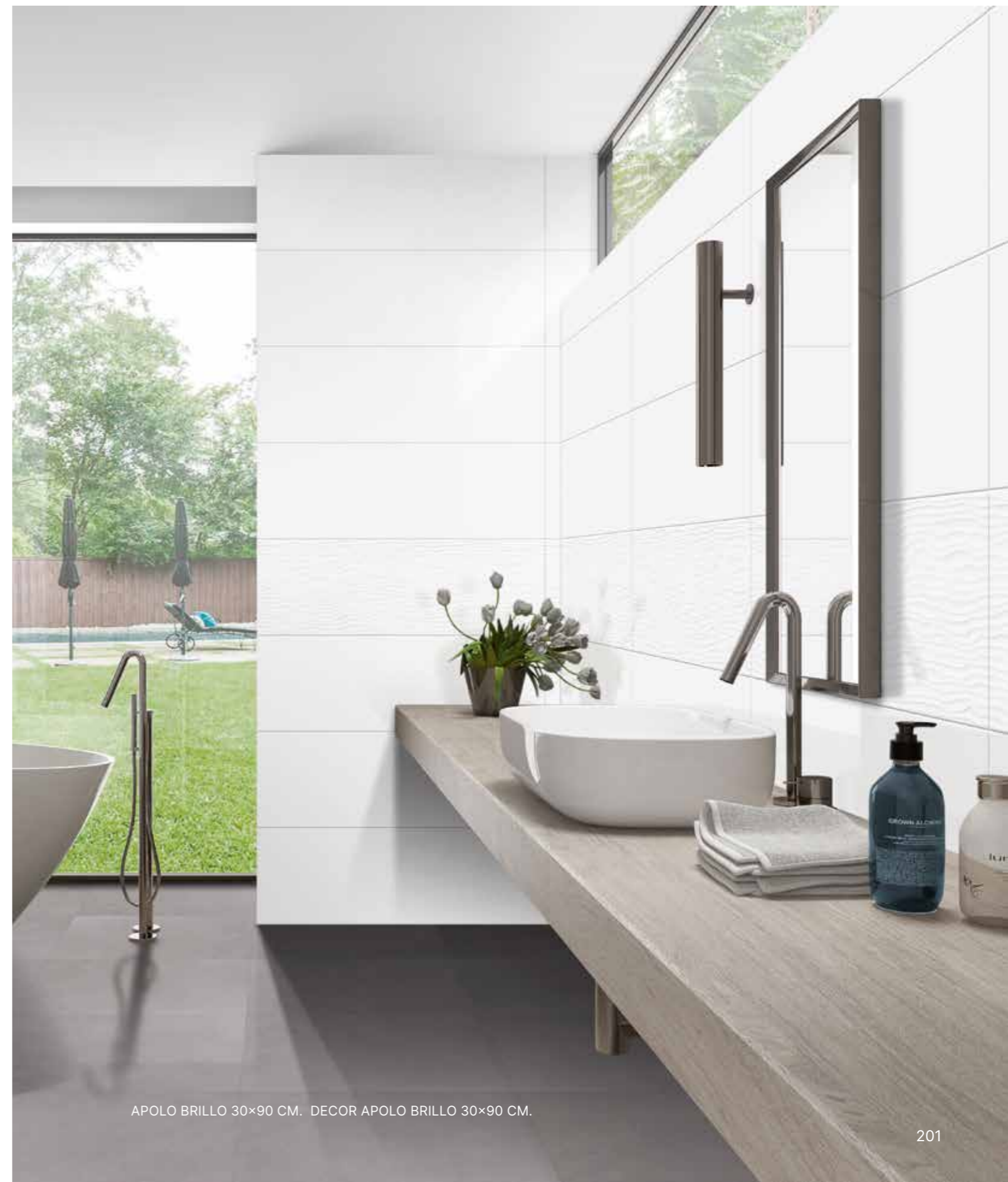

APOLO BRILLO 30×90 CM. DECOR APOLO BRILLO 30×90 CM.

Star

PORCELAIN PORCELÁNICO

WHITES BLANCOS

general book 2024

villa
cerámica

TECHNICAL FEATURES CARACTERÍSTICAS TÉCNICAS

V1 **G M M P** 60×120

Star

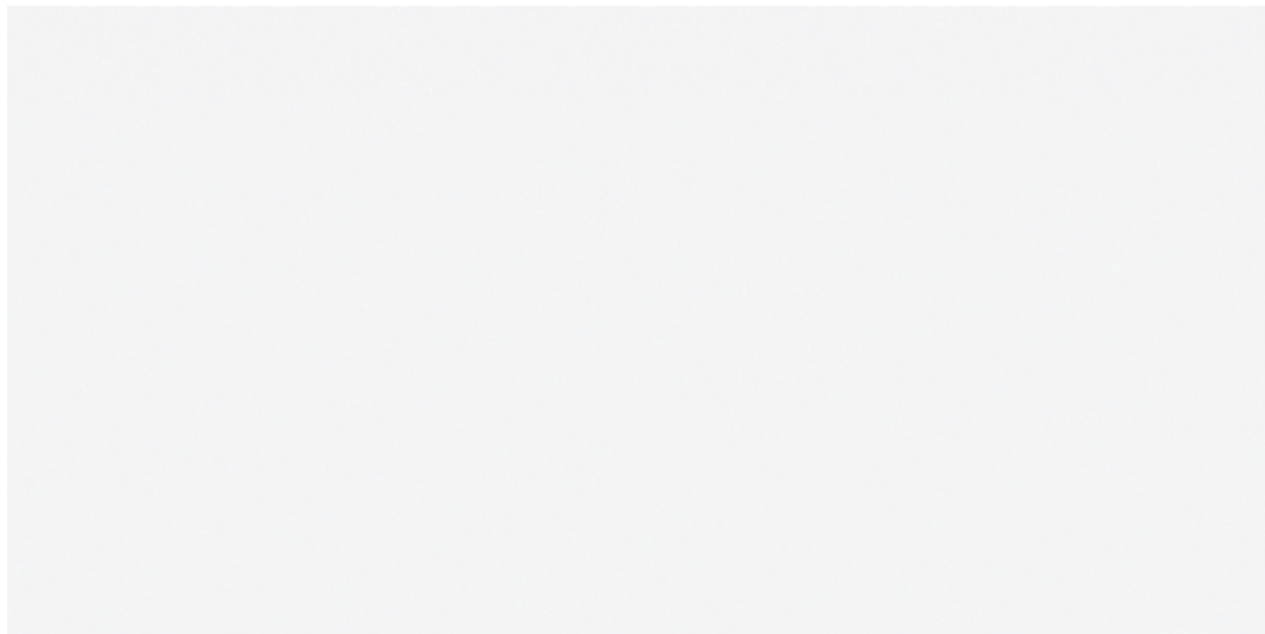

AVAILABLE SIZES FORMATOS DISPONIBLES

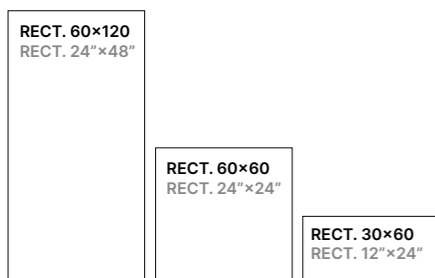

RECT. 60×120	●
RECT. 60×60	●
RECT. 30×60	●

Mosaicos, rodapiés y peldaños disponibles bajo solicitud, ver pag. 211.
Mosaics, skirting boards and steps available on request, see page 211.

PACKING LIST EMBALAJE

SIZE FORMATO	PIECES BOX PIEZAS CAJA	M ² BOX M ² CAJA	KG BOX KG CAJA	BOXES CAJAS	M ² PALLET M ² PALLET	KG PALLET KG PALLET
RECT. 60×120	2	1,44	30,34	32	46,08	991
RECT. 60×60	4	1,44	28,1	30	43,2	862
RECT. 30×60	8	1,44	25,2	60	86,4	1.532

STAR POLISHED 60×120 CM.

technical area



LAYING RECOMMENDATIONS

Correct, careful laying of Villa Cerámica, is ceramic products are vital for taking full advantage of their technical characteristics. For this reason, the following points are necessary:

- ↳ Check the caliber, tone and quality of the product before laying.
- ↳ Choose appropriate installation tools (toothed trowel, white rubber hammer, suction grip and rubber trowel for pointing).
- ↳ Ensure that the surface on which the material is to be laid is level, clean and insulated from damp.
- ↳ Pay special attention to the type of adhesive to be used (consult the habitual adhesive supplier), since each type of ceramic requires the appropriate adhesive. (Standard of reference: EN-1348).
- ↳ For rectangular and/or large formats (side larger than 60 cm) the use of a leveling system such as wedges are recommended to ensure a correct installation.
- ↳ The professional responsible for laying the material must choose the appropriate joints between pieces and the perimeter joints, in order to guarantee correct absorption of structural movements, and an allowance for dimensional tolerances of the product. Villa Ceramica recommends laying the tiles with a minimum joint of 2mm and checking for other indications given on the box (measurements between calibers, recommended joint).
- ↳ Do not use colored pointing material containing black smoke (micronized carbon) or dyes which can hamper the cleaning of the tiled surface.
- ↳ Clean off excess pointing material from the surface of the tiles when it is still fresh, using a sponge and clean water; never use hard materials that could scratch the tiles, such as metal spatulas or abrasive scourers. Always follow the recommendations given by the adhesive manufacturer.
- ↳ Once the tiles are laid, avoid working in the tiled zone (plastering, painting, placing scaffolds/ladders, projecting metallic fragments from disc grinders, moving tools, dragging heavy objects, moving remains of abrasive building materials, etc.) If this cannot be avoided, always protect the tiles and joints to prevent problems of cleaning or deterioration. The materials used for this protection must not be harmful or contain chemical products which may damage the tiling.

RECOMENDACIONES DE COLOCACIÓN

Una colocación adecuada y cuidadosa de los productos fabricados por Villa Cerámica es vital para hacer resaltar al máximo las características técnicas de los mismos. Por este motivo, es necesario:

- ↳ Verificar el calibre, tono y calidad del producto, antes de la colocación. Reclamaciones acerca de estos puntos tras la colocación no serán aceptadas.
- ↳ Escoger herramientas de instalación adecuadas (llana dentada, maza de goma blanda, ventosa y llana de goma para la aplicación de la junta).
- ↳ Que la superficie sobre la cual vaya a instalarse el material esté nivelada, limpia y aislada de la humedad.
- ↳ Prestar especial atención al tipo de adhesivo a utilizar (consultar con el proveedor habitual de adhesivos), dado que cada tipo de cerámica requiere el adhesivo adecuado. (Norma de referencia: EN-1348).
- ↳ Para formatos rectangulares y/o de gran formato (lado mayor de 60 cm) se recomienda el uso de sistemas nivelados como campanas o cuñas para garantizar una correcta colocación.
- ↳ El profesional responsable de la colocación del material, debe elegir adecuadamente las juntas entre piezas, así como las juntas perimetrales, de manera que se garantice una correcta absorción de movimientos estructurales, y una compensación de tolerancias dimensionales del producto. Villa Cerámica recomienda colocar la cerámica con una junta mínima de 2 mm y comprobar si en la caja hay otras indicaciones (medidas entre calibres o junta recomendada).
- ↳ No se debe utilizar junta de color que contenga negro de humo (carbón micronizado), ni tintes que pueden dificultar la limpieza de la superficie revestida.
- ↳ Limpiar los restos de rejuntado de la superficie de las baldosas cuando aún están frescos, utilizando una esponja con agua limpia; en ningún caso deben utilizarse materiales que presenten alta dureza y puedan rayar el producto cerámico tales como espátulas metálicas o estropajos abrasivos. Siempre se deben seguir las recomendaciones indicadas por el fabricante de adhesivos.
- ↳ Una vez colocado el azulejo, hay que evitar las operaciones en la zona alicatada (enyesado, pintura, colocación andamios/escaleras, proyección de restos metálicos de radiales, trasiego de herramientas, arrastre de objetos pesados, resto de materiales abrasivos de obra, etc.), en caso contrario, siempre hay que proteger las baldosas y las juntas para evitar posteriores problemas de limpieza o deterioro. El material que se use para esta protección, no debe dañar ni contener productos químicos que dañen al azulejo.

SPECIAL FOR THE SHADE VARIATION SERIES

To obtain an excellent aesthetic finish in terms of design and to appreciate all of its qualities, Villa Ceramica recommends mixing tiles from the greatest possible number of boxes before starting installation. Already fixed material claims, related with the before mentioned points will not be accepted.

SPECIAL FOR LAYING RECTANGULAR FORMATS

When laying rectangular formats discontinuously, never do so in the center of the piece. In order to maintain the aesthetic appearance and avoid difficulties in installation, we recommend that discontinuous laying does not exceed 25% of the side to which it is applied. For rectangular and large formats (side larger than 60 cm) the use of a leveling system such as wedges are recommended to ensure a correct installation.

ESPECIAL PARA LAS SERIES DESTONIFICADAS

Para obtener un excelente acabado estético en cuanto al diseño y apreciar todas sus cualidades, Villa Cerámica recomienda que se mezclen baldosas del mayor número de cajas posible antes de iniciar la instalación.

ESPECIAL COLOCACIÓN DE FORMATOS RECTANGULARES

La colocación a rompejunta de formatos rectangulares nunca debe realizarse en la mitad de la pieza. Se aconseja que para mantener la estética y evitar dificultades en su instalación, la colocación a rompejunta no supere el 25% del lado sobre el que se aplica. Para formatos rectangulares y/o de gran formato (lado mayor de 60 cm.) se recomienda el uso de sistemas de nivelación como campanas o cuñas para garantizar una correcta colocación.

Users guide

Guía de uso

MAINTENANCE

To maintain the beauty and elegance of Villa Cerámica, we advise daily cleaning with conventional methods. To remove remains of dust and solids: sweeping or vacuum cleaning.

Do not use dust-catcher mops with silicones and waxes. The surface must be washed with neutral soap and the amount of hot water recommended by the manufacturer.

Do not use cleaning products containing wax, brighteners or similar additives, since in time they may leave a waterproof layer on the tile which alters its surface appearance. We strongly recommend the use of doormats, which must remain clean, in entrances to tiled areas, whether from the street, terrace or garden, to prevent the entry of abrasive elements.

We recommend special care in zones close to beaches or construction works, where there is a risk of sand and stones being brought in. It is advisable to place protections on objects which can mark the tiles if dragged (metal table legs, chairs, etc.), being especially careful with shiny and satin-finished products. If the tiles cannot be cleaned completely, we provide the following table showing suitable cleaning agents for each type of dirt:

Oil, ink, marker pen, tomato, fruit, chocolate, grease.

- Organic solvents: alcohol, turpentine, acetone.
- Alkaline detergents in liquid or powder form
- Bicarbonate.

Tar, rubber, shoe polish, paint, graffiti, wax, resins, marker pen, nail varnish.

- Organic solvents: alcohol, turpentine, acetone.

Coffee, ice cream, nicotine, wine.

- Alkaline detergents in liquid or powder form.

Lime, cement, beer, metal deposits, soft drinks, fruit juices

- Diluted acids: vinegar, hydrochloric acid.

Glue, chewing gum, tire or shoe rubber.

- Organic solvents: alcohol, turpentine, acetone.
- Diluted acids: hydrochloric acid.

Blood, mercromina, iodine.

- Oxidant: oxygenated water.

Incrustations.

- Pressurized water.

MANTENIMIENTO

Para mantener la belleza y elegancia de la cerámica Villa Cerámica, se aconseja la limpieza periódica del material, con sistemas convencionales. Para la eliminación de restos de polvo y sólidos: por barrido o aspiración.

No se debe utilizar mopas atrapa polvo con siliconas y ceras. El lavado de la superficie se debe realizar con jabón neutro y la cantidad de agua caliente recomendada por el fabricante

No se deben usar productos de limpieza abrillantadores, cerosos o con aditivos similares ya que con el paso del tiempo pueden dejar una capa impermeabilizante sobre la cerámica que altera el aspecto superficial de la misma. Es recomendable la colocación de felpudos, que deberán permanecer limpios, en las entradas a los lugares pavimentados, ya sea desde la calle, terrazas o jardines, para evitar la entrada de elementos abrasivos.

Se recomienda especial cuidado en zonas cercanas a playas u obras que pueden aportar arenas y piedras. Es aconsejable poner protecciones a los objetos que por arrastre pudieran marcar el producto (patas metálicas de mesas, sillas, etc.), teniendo especial rigurosidad con productos brillantes y satinados. Si la suciedad no se elimina completamente, facilitamos la siguiente tabla, donde se encuentran los agentes limpiadores adecuados para cada tipo de suciedad:

Aceite, chocolate, tomate, frutas, grasa, tinta, rotulador.

- Disolvente orgánico: alcohol, aguarrás, acetona.
- Detergente alcalino ya sea en líquido o en polvo.
- Bicarbonato.

Alquitrán, caucho, betún, pintura, graffiti, cera, resina, rotulador, esmalte de uñas.

- Disolvente orgánico: alcohol, aguarrás, acetona.

Café, helado, nicotina, vino.

- Detergente alcalino ya sea líquido o en polvo.

Cal, cemento, cerveza, depósitos metálicos, refrescos, zumos

- Ácidos diluidos: vinagre, sulfamán o ácido clorhídrico.

Cola, goma de mascar, goma de neumático o zapato.

- Disolvente orgánico: alcohol, aguarrás o acetona
- Ácidos diluidos: sulfamán o ácido clorhídrico.

Sangre, Mercromina, Yodo.

- Oxidante: Agua oxigenada.

Incrustaciones.

- Agua a presión.

Never use any products containing hydrofluoric acid, only those indicated in the table above. All the products shown in the table can easily be found in ordinary household stores and shopping centres.

Special for polished porcelain tiles: In the case of polished porcelain tiles, once all the material has been laid and the remains of cement, pointing and any other building material have been cleaned off, on some polished surfaces the presence of an 'oily' film can be observed due to the 'stainresistant' inertisation treatment they are given. If this occurs, Villa Cerámica recommends cleaning the surface with dry cleaning products (detergents in powder form) and, once this fine protective film has been eliminated, cleaning the tiles as indicated above.

In extreme lighting conditions, light reflections may occur due to the high degree of brightness and the characteristics of the product. We recommend removing stains immediately.

Nunca hay que utilizar productos que contengan fluorhídrico, sólo los indicados en la tabla anterior. Todos los productos indicados en la tabla se pueden encontrar fácilmente en droguerías y centros comerciales habituales.

Especial para porcelánicos pulidos: Una vez instalado todo el material y habiendo limpiado los restos de cemento, rejuntado y cualquier material de obra, en algunos productos pulidos, debido al tratamiento superficial de inertización "anti manchas" que se le realiza, puede observarse la presencia de una película "grasa" en la superficie de las piezas. En caso de presentarse esta situación, Villa Cerámica recomienda la limpieza de la superficie con productos de limpieza en seco (detergentes en polvo), y una vez eliminada esa fina película protectora proceder a la limpieza del producto de la forma anteriormente indicada.

Por otro lado, en condiciones extremas de iluminación se pueden producir reflejos y sombras debido al alto grado de brillo y las características del producto. Se recomienda limpiar las manchas de forma inmediata.

Symbology

Simbología

P POLISHED PULIDO

M MATT MATE

S MATT SATIN MATE SATINADO

G GLOSSY BRILLO

H HONED APOMAZADO

L LAPATTO LAPADO

V GRAPHIC VARIATION VARIACIÓN GRÁFICA

S/P SUPER POLISHED SUPER PULIDO

H/P HIGH POLISHED PULIDO ALTO BRILLO

M/S MATT STRUCTURED MATE ESTRUCTURADO

P/S POLISHED SATIN PULIDO SATINADO

ANTISLIP ANTISLIP ANTIDESLIZANTE

Technical information

Información técnica

general book 2024

villa
ceramica

	RED & WHITE BODY WALL TILES REV - PAV PASTA ROJA, BLANCA PÂTE ROUGE / BLANCHE ROTE WEISSE SCHERBEN	PORCELAIN GRES PORCELÁNICO GRES CERAME FEINSTEINZEUG
	NORMA EN 14411:E ISO 13006 ANEXO L GRUPO BIII.	NORMA EN 14411:E ISO 13006 ANEXO G GRUPO BIA.
TECHNICAL CHARACTERISTICS CARACTERÍSTICAS TÉCNICAS CHARACTERISTIQUES TECHNIQUES TECHNISCHE EIGENSCHAFTEN	Norm value Valor de la norma Valeur de la norme Wert gemäss der norm	Norm value Valor de la norma Valeur de la norme Wert gemäss der norm
LENGTH AND WIDTH (ISO 10545-2) LONGITUD Y ANCHURA LONGUERUR ET LARGEUR LÄNGE UND BREITE	+0.6% / - 0.3%	+0.6%
WEDGING (ISO 10545-2) ORTOGONALIDAD ORTHOGONALITÉ RECHTWINKLIGKEIT	±0.3%	±0.5%
WARPAGE OF EDGES (ISO 10545-2) RECTITUD DE LOS LADOS RECTITUDE DES ARÊTES KANTENGERADHEIT	±0.3%	±5%
THICKNESS (ISO 10545-2) GROSOR EPAISSEUR DICKE	±10%	±0.5%
FLATNESS (ISO 10545-2) PLANITUD DE LA SUPERFICIE PLANITUDEÉ EBENMÄSSIGKEIT DER OBERFLÄCHE	+0.8 MM / -0.2 MM	±0.5%
WATER ABSORPTION (ISO 10545-3) ABSORCIÓN DE AGUA ABSORPTION D'EAU WASSERABSORPTION	> 10%	≤ 0.5%
FORCE OF BREAKAGE FUERZA DE ROTURA FORCE DE RUPTURE	*Espesor < 7.5mm min 200n *Espesor ≥ 7.5 Mm min 600n	*Espesor < 7.5mm Min 700N *Espesor ≥ 7.5 mm Min 1300N
THERMAL SHOCK (ISO 10545-9) CHOQUE TÉRMICO RESISTANCE AU CHOC THERMIQUE TEMPERATURWECHSELBESTÄNDIGKEIT	Passes standard test Pasa satisfactoriamente el ensayo A validé le test standard Hat den standartest bestanden	Passes standard test Pasa satisfactoriamente el ensayo A validé le test standard Hat den standartest bestanden
RESISTANCE TO CRACKING (ISO 10545-11) RESISTENCIA AL CUARTEO RESISTANCE FENDAGE RISSFESTIGKEIT	Passes standard test Pasa satisfactoriamente el ensayo A validé le test standard Hat den standartest bestanden	Passes standard test Pasa satisfactoriamente el ensayo A validé le test standard Hat den standartest bestanden
RESISTANCE TO STAINS (ISO 10545-14) RESISTENCIA A LAS MANCHAS RÉSISTANCES AUX TACHES FLECKENMPFINDLICHKEIT	Class 3 min / mínimo clase 4 Classe 3 min / min klasse 3	Class 3 min / mínimo clase 4 Classe 3 min / min klasse 3
ACIDS BASES (ISO 10545-15) ÁCIDOS Y BASES / ACIDE BASES / SÅUREN BASEN	By te manufacturer indicado por el fabricante Indiqué par le producteur siehe angabe des herstellere	By te manufacturer indicado por el fabricante Indiqué par le producteur siehe angabe des herstellere
RESIDENTIAL (SWIMMING POL) CHEMICALS (ISO 10545-13) RESISTENCIA A LOS PRODUCTOS DE LIMPIEZA Y REACTIVOS DE PISCINAS PRODIGITS DOMESTIQUES ET ADDITFS POUR PISCINES HAUSHALTS-CHEMIKALIEN UND SCHWIMMBA- DZUSÄTZE	Mínimo clase gb-ub clase gb-ub min clase gb-ub min min klasse gb-ub	Mínimo clase gb-ub clase gb-ub min clase gb-ub min min klasse gb-ub

Mosaics

Mosaicos

We adapt to the customers request. (Any format, shape, draw...)
Nos adaptamos a las peticiones de los clientes. (Cualquier formato, forma, dibujo...)

Example:

5×5 CM. 2"×2"

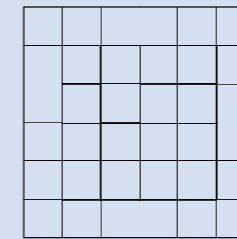

10×10 CM. 4"×4"

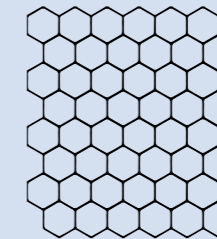

Skirting board, rain gutter and steps

Rodapié, vierteaguas y peldaño

Skirting board available formats
Formatos disponibles rodapié

Steps available formats
Formatos disponibles peldaño

7,5×40 CM. 3"×16"

7,5×60 CM. 3"×24"

7,5×90 CM. 3"×35"

7,5×120 CM. 3"×47"

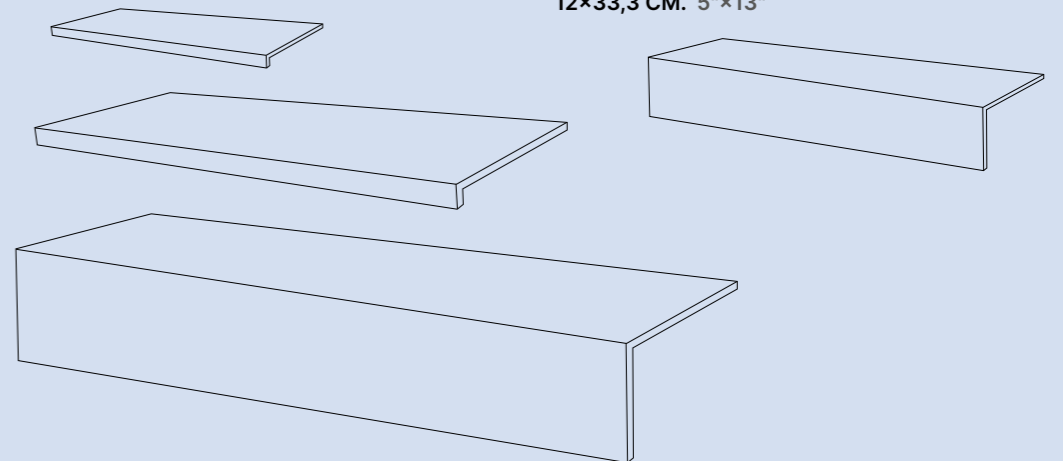

ENG The production of the colours is approximate. Villa Cerámica reserves the right to alter or amend the products here stated. Due to the difference in manufacturing of raw materials and firing process between floor tiles and wall tiles, Villa Cerámica cannot guarantee the same shade between those two products and will not accept any claims for shade differences between floor/wall combinations.

ESP La reproducción de los colores es aproximada. Villa Cerámica se reserva el derecho de alterar o modificar los productos aquí relacionados. Debido a las diferencias en la producción de la materia prima y las temperaturas de cocción entre revestimientos y pavimentos, villa ceramica no puede garantizar el mismo tono entre revestimientos y pavimentos de la misma serie. Villa Cerámica no acepta reclamaciones de tonos entre combinaciones de revestimientos y pavimentos.

FR La reproduction des couleurs est approximative. Villa Cerámica se réserve le droit de changer ou de modifier les produits énumérés ici. En raison des différences de production des matières premières et des températures de cuisson entre le revêtements de mur et sol, Villa Cerámica ne peut garantir la même nuance entre faïence et sol d'une même série.